

 Uso domestico

 Uso civile

 Uso industriale

 Uso agricolo

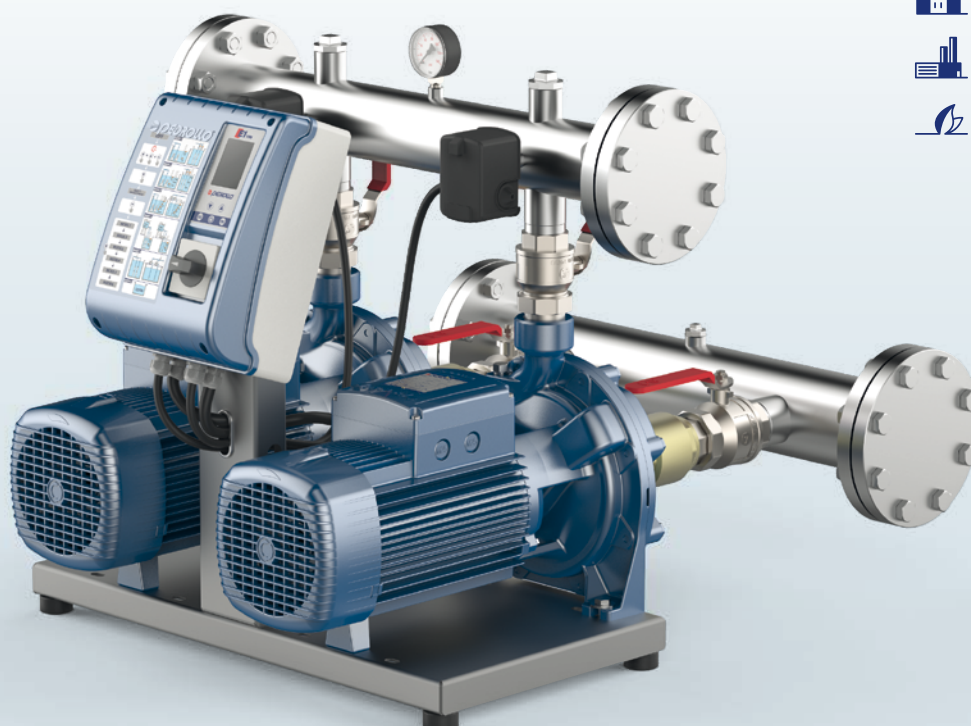

UTILIZZI ED INSTALLAZIONI

CB2 è un sistema di pompaggio preassemblato composto da due elettropompe e indicato per l'alimentazione e la pressurizzazione idrica in edifici residenziali, commerciali, pubblici, alberghi o ospedali e per l'irrigazione di giardini, campi sportivi e coltivazioni agricole.

CB2 è idoneo per il pompaggio di acqua pulita o soluzioni acquose che non danneggino chimicamente o meccanicamente i materiali utilizzati e non contengano sostanze abrasive o fibrose.

DESCRIZIONE DEL PRODOTTO

CB2 è un sistema di pressurizzazione a due elettropompe assemblate in una unità pronta per il collegamento alla rete idrica oppure a un serbatoio di prima raccolta e gestito da pressostati meccanici.

CB2 è predisposto in modo che, a ogni incremento di richiesta da parte dell'utenza, si avviino automaticamente una o entrambe le pompe in successione in modo da soddisfare il fabbisogno idrico dell'impianto e ridurre i consumi elettrici.

Il circuito elettronico presente nel quadro di comando permette lo scambio automatico delle pompe a ogni ciclo di avviamento/arresto e la protezione del gruppo di pompaggio in caso di anomalie.

CARATTERISTICHE COSTRUTTIVE

- ※ **ELETTROPOMPE** collegate in parallelo mediante collettori in aspirazione e mandata. Ogni unità è dotata di valvole a sfera in mandata e aspirazione, di valvole di non ritorno in aspirazione (con pompe 2CP, 3-5CR, FCR, MK) o in mandata (con pompe HT).
- ※ **BASAMENTO** realizzato in profilato metallico e dotato di piedini antivibranti regolabili.
- ※ **PRESSOSTATI** montati sul collettore di mandata e collegati al quadro di comando per l'inserimento e il disinserimento delle pompe in base alla regolazione.
- ※ **QUADRO ELETTRONICO** (modello **E2**) Garantisce la protezione contro la marcia a secco tramite la lettura dei parametri elettrici e consente agli utenti più esperti di modificare i parametri per adattare il funzionamento del gruppo di pressione alle caratteristiche specifiche dell'impianto.
- ※ Alimentazione elettrica:
 - **CB2m**: monofase 230 V - 50 Hz
 - **CB2**: trifase 400 V - 50 Hz



CB2 – 2CP

Gruppi di pressurizzazione composti da due elettropompe centrifughe bigirante.

Adatti per l'approvvigionamento idrico residenziale e commerciale, l'irrigazione di grandi giardini, campi sportivi e coltivazioni agricole e per la movimentazione di acqua pulita in genere, anche in campo industriale.

DATI TECNICI

- Temperatura del liquido da **+5 °C** fino a **+55 °C**
- Temperatura ambiente da **+5 °C** fino a **+40 °C**
- Pressione max nel corpo pompa **10 bar** (6 bar per 2CP25/130)
- Servizio continuo **S1**



CB2 – 3-5CR

Gruppi di pressurizzazione composti da due elettropompe centrifughe multistadio. Sono adatti per l'approvvigionamento idrico domestico, per l'irrigazione di giardini e per la movimentazione di acqua pulita in genere.

DATI TECNICI

- Temperatura del liquido da **+5 °C** fino a **+55 °C**
- Temperatura ambiente da **+5 °C** fino a **+40 °C**
- Pressione max nel corpo pompa **7 bar**
- Servizio continuo **S1**



CB2 – FCR

Gruppi di pressurizzazione composti da due elettropompe centrifughe multistadio orizzontali.

Particolarmente adatti per l'approvvigionamento idrico residenziale e commerciale, aumento di pressione in applicazioni industriali, irrigazione di giardini e campi sportivi.

DATI TECNICI

- Temperatura del liquido da **+5 °C** fino a **+55 °C**
- Temperatura ambiente da **+5 °C** fino a **+40 °C**
- Pressione max nel corpo pompa **11 bar** (per FCR 80-100 **7 bar**)
- Servizio continuo **S1**



CB2 – MK

Gruppi di pressurizzazione composti da due elettropompe centrifughe multistadio verticali.

Sono adatti per l'approvvigionamento idrico residenziale e commerciale, l'irrigazione di giardini e per la movimentazione di acqua pulita in genere.

DATI TECNICI

- Temperatura del liquido da **+5 °C** fino a **+55 °C**
- Temperatura ambiente da **+5 °C** fino a **+40 °C**
- Pressione max nel corpo pompa **11 bar**
- Servizio continuo **S1**



CB2 – HT

Gruppi di pressurizzazione composti da due elettropompe centrifughe multistadio verticali.

Sono adatti per l'approvvigionamento idrico residenziale e commerciale, per l'irrigazione e per la movimentazione di acqua pulita in genere, anche in campo industriale.

DATI TECNICI

- Temperatura del liquido da **+5 °C** fino a **+55 °C**
- Temperatura ambiente da **+5 °C** fino a **+40 °C**
- Pressione max nel corpo pompa **16 bar**
- Servizio continuo **S1**

CB2 - 2CP

CAMPO E DATI DI PRESTAZIONE

50 Hz

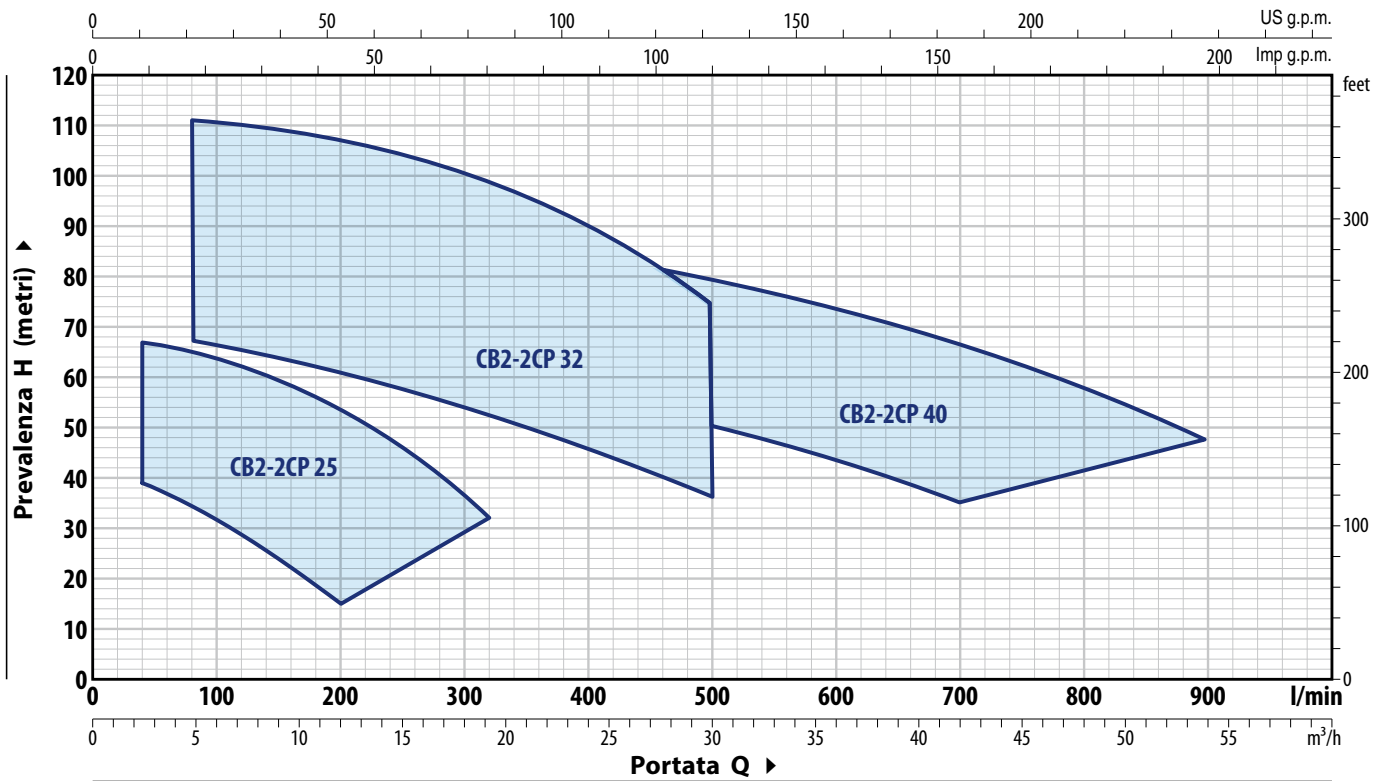

Monofase	TIPO		POTENZA P ₂		Q	m ³ /h											
	Trifase		kW	HP		0	2.4	4.8	7.2	9.6	10.8	12.0	13.2	14.4	16.8	19.2	
CB2 - 2CPm 25/130	-		2x0.75	2x1	H metri	0	40	80	120	160	180	200	220	240	280	320	
CB2 - 2CPm 25/14B	CB2 - 2CP 25/14B		2x1.1	2x1.5		42	39	34.5	28.5	22	18	15					
CB2 - 2CPm 25/16C	CB2 - 2CP 25/16C		2x1.1	2x1.5		54	52	47.5	41	32.5	27.5	22					
CB2 - 2CPm 25/16B	CB2 - 2CP 25/16B		2x1.5	2x2		47	46	44	40.5	36	33.5	30.5	27.5	24			
-	CB2 - 2CP 25/16A		2x2.2	2x3		58	56	54	51	47.5	45.5	43	40	37	30		
						68	67	65	62	58.5	56	54	51	48	40.5	32	

Monofase	TIPO		POTENZA P ₂		Q	m ³ /h										
	Trifase		kW	HP		0	4.8	7.2	9.6	12.0	14.4	16.8	19.2	21.6	24.0	30.0
-	CB2 - 2CP 32/200C		2x3	2x4	H metri	0	80	120	160	200	240	280	320	360	400	500
-	CB2 - 2CP 32/200B		2x4	2x5.5		70	67	65	63	60.5	58	55	52	48.5	45.5	36
-	CB2 - 2CP 32/210B		2x5.5	2x7.5		85	81	79	77	74.5	71.5	69	66	62.5	59	49
-	CB2 - 2CP 32/210A		2x7.5	2x10		94	94	93	91	89	86	83	79	75	70	56
						112	111	110	109	107	105	102	99	95	90	74

Monofase	TIPO		POTENZA P ₂		Q	m ³ /h								
	Trifase		kW	HP		0	12	18	24	30	36	42	48	54
-	CB2 - 2CP 40/180C		2x4	2x5.5	H metri	0	200	300	400	500	600	700	800	900
-	CB2 - 2CP 40/180B		2x5.5	2x7.5		65	63	60	55.5	50	43	35		
-	CB2 - 2CP 40/180A		2x7.5	2x10		80	78	75	71	65.5	59	51	42	
						92	90	87.5	84	79	73.5	66	58	48

Q = Portata H = Prevalenza manometrica totale

Tolleranza delle curve di prestazione secondo EN ISO 9906 Grado 3B.

✳ I dati rappresentati nel diagramma e nelle tabelle, indicano le prestazioni con 2 pompe in funzionamento

CURVE DI PRESTAZIONE

50 Hz

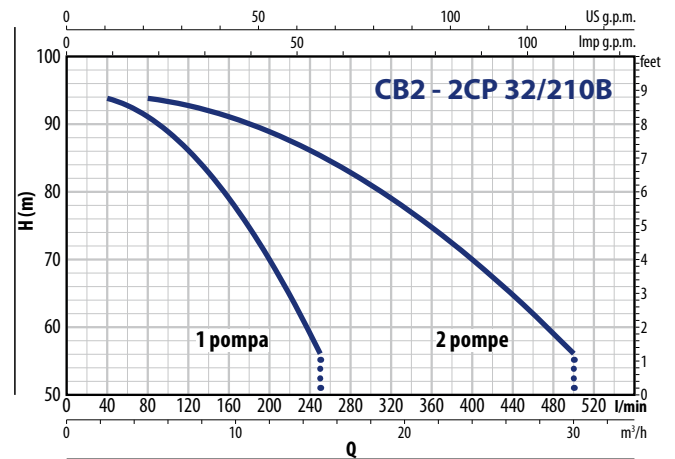
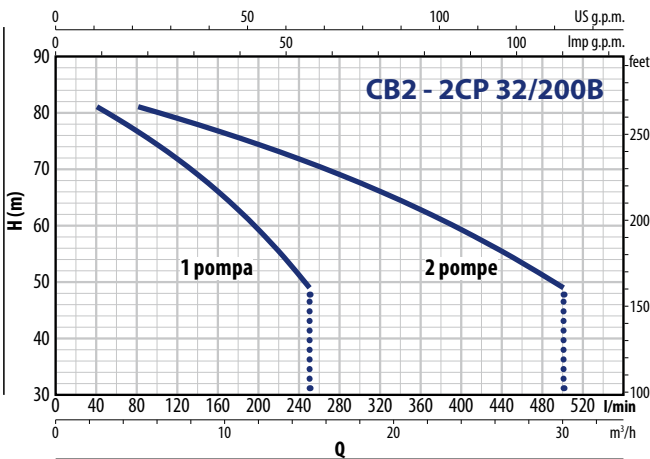
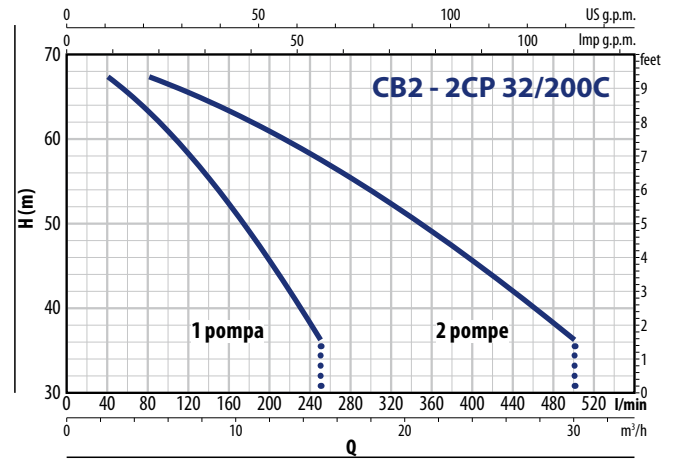
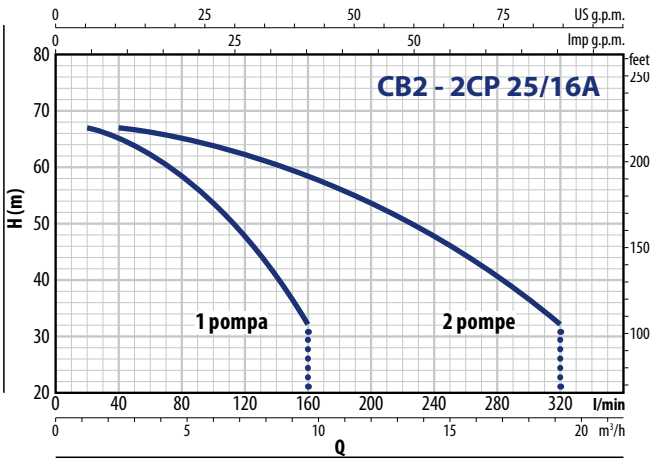
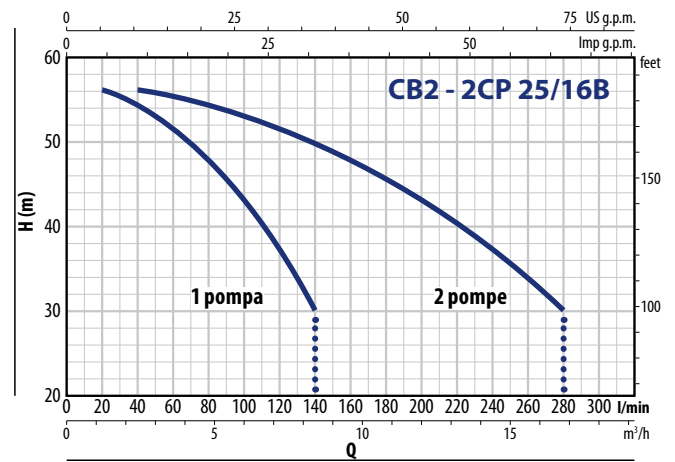
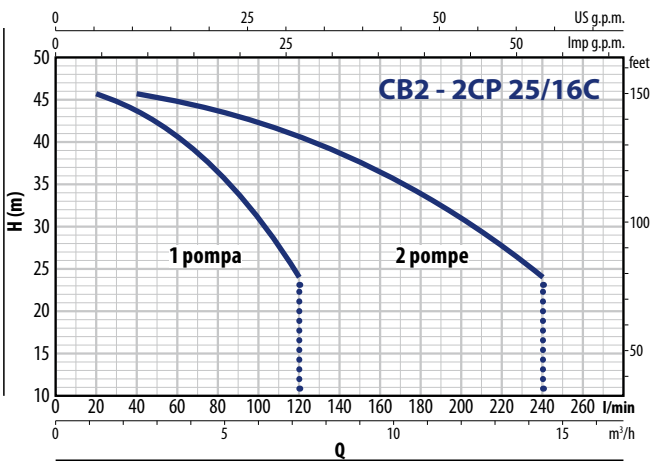
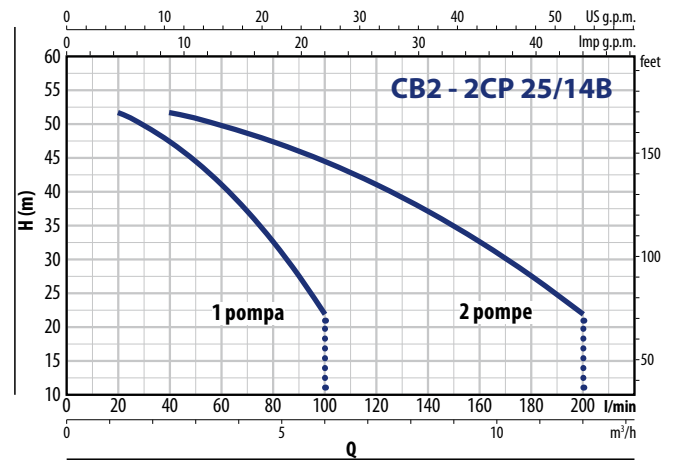
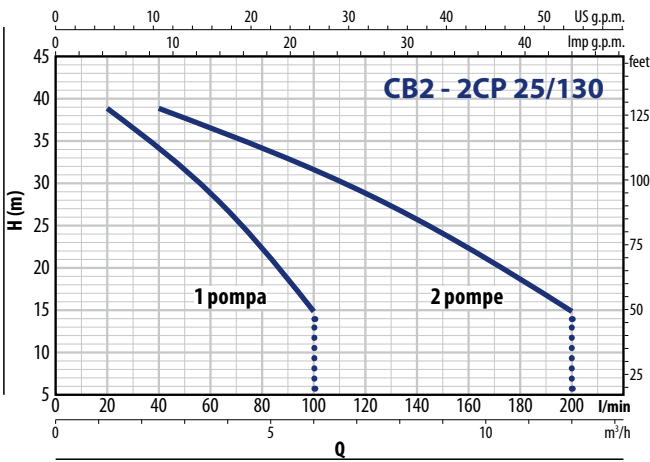

CB2 - 2CP

CURVE DI PRESTAZIONE

50 Hz

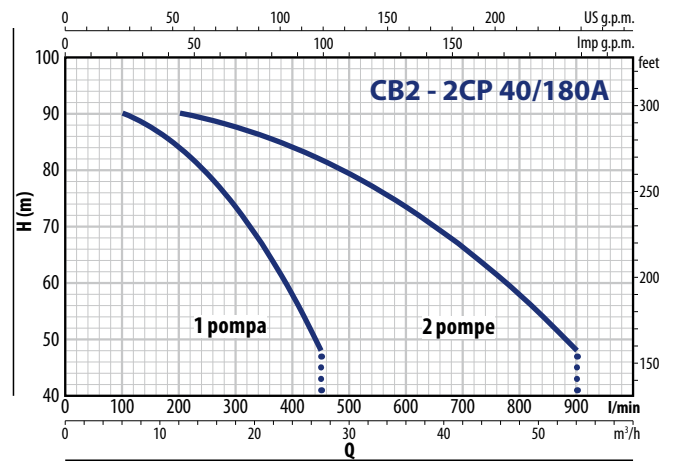
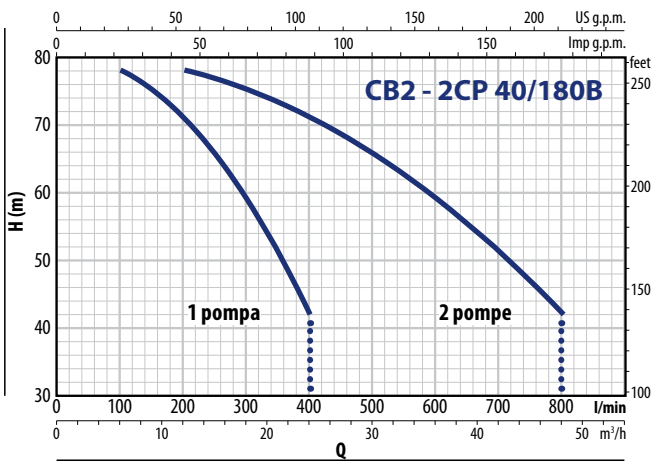
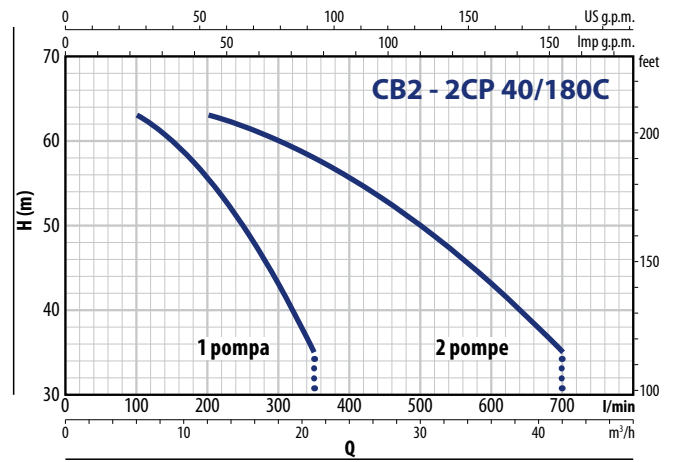
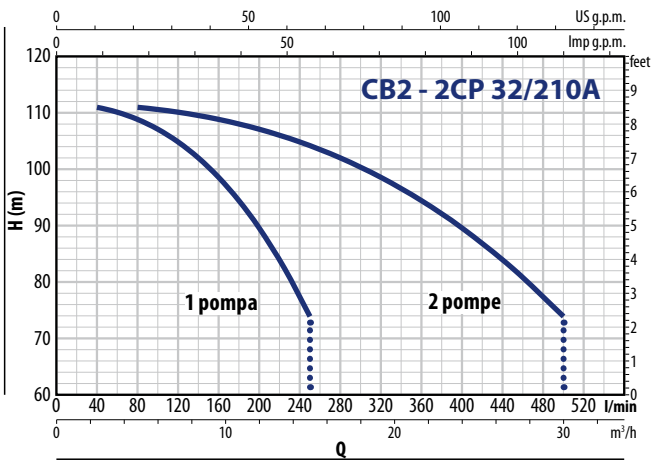

ASSORBIMENTI

TIPO	TENSIONE
Monofase	230 V
CB2 - 2CPm 25/130	2 x 6.3 A
CB2 - 2CPm 25/14B	2 x 7.7 A
CB2 - 2CPm 25/16C	2 x 7.7 A
CB2 - 2CPm 25/16B	2 x 10.0 A

TIPO	TENSIONE
Trifase	400 V
CB2 - 2CP 25/14B	2 x 3.1 A
CB2 - 2CP 25/16C	2 x 3.1 A
CB2 - 2CP 25/16B	2 x 4.0 A
CB2 - 2CP 25/16A	2 x 5.3 A
CB2 - 2CP 32/200C	2 x 7.4 A
CB2 - 2CP 32/200B	2 x 10.5 A
CB2 - 2CP 32/210B	2 x 12.5 A
CB2 - 2CP 32/210A	2 x 16.0 A
CB2 - 2CP 40/180C	2 x 9.8 A
CB2 - 2CP 40/180B	2 x 12.3 A
CB2 - 2CP 40/180A	2 x 15.4 A

DIMENSIONI E PESI

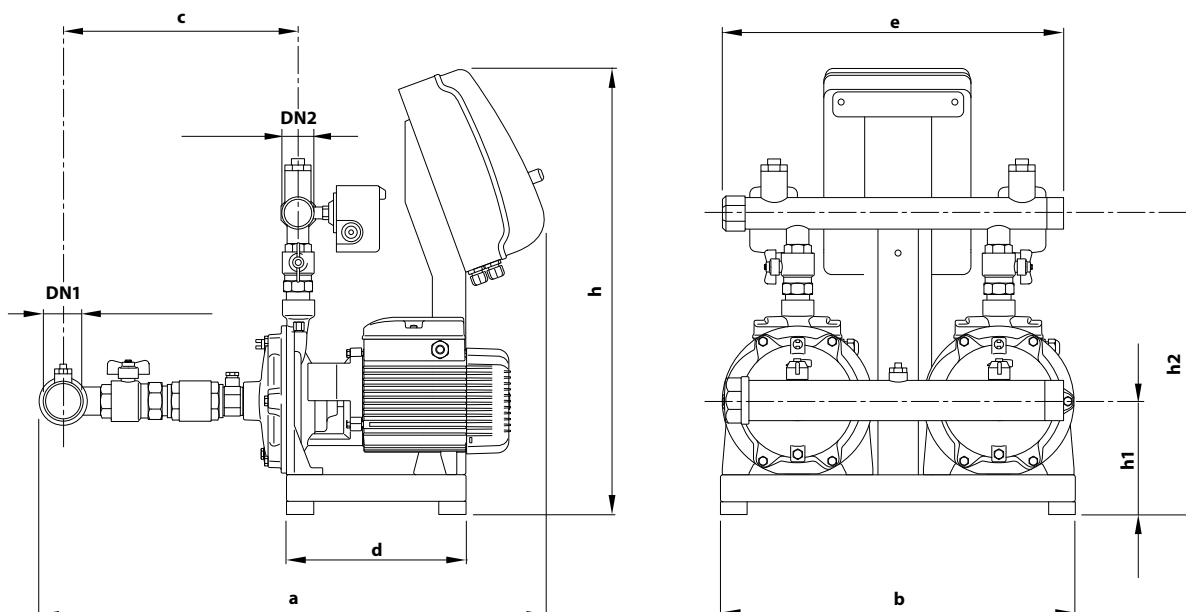

TIPO		BOCCHE		DIMENSIONI mm								kg	
Monofase	Trifase	DN1	DN2	a	b	c	d	e	h	h1	h2	1~	3~
CB2 - 2CPm 25/130	–	2"	1½"	727	530	337	270	510	674	152	390	60.0	–
CB2 - 2CPm 25/14B	CB2 - 2CP 25/14B			752		453				153	413	72.0	73.0
CB2 - 2CPm 25/16C	CB2 - 2CP 25/16C			761		456				170	451	73.0	73.0
CB2 - 2CPm 25/16B	CB2 - 2CP 25/16B			–		–				–	–	80.0	80.0
–	CB2 - 2CP 25/16A	3"	2"	972	700	453	370	712	199	192	516	–	129.0
–	CB2 - 2CP 32/200C			977		456				546	–	161.0	
–	CB2 - 2CP 32/200B			–		–				–	–	171.0	
–	CB2 - 2CP 32/210B			–		–				–	–	–	
–	CB2 - 2CP 32/210A	DN 100 4"	DN 80 3"	1048	–	468	–	774	716	590	–	190.0	
–	CB2 - 2CP 40/180C			–		–		–	–	–	199.0		
–	CB2 - 2CP 40/180B			–		–		–	–	–	211.0		
–	CB2 - 2CP 40/180A	–	–	–	–	–	–	–	–	–	–	–	

CB2 - 4-5CR

CAMPO E DATI DI PRESTAZIONE

50 Hz

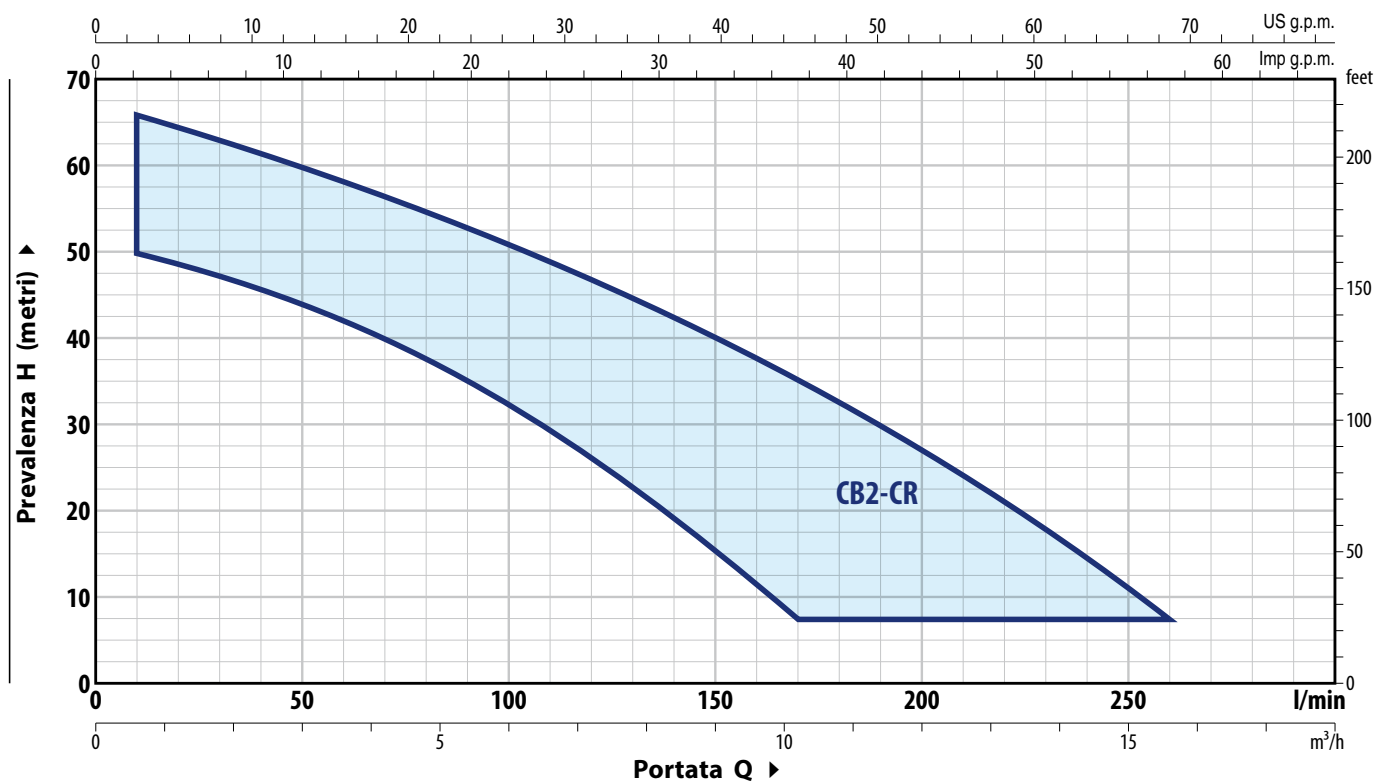

TIPO		POTENZA (P ₂)		Q	m ³ /h															
Monofase	Trifase	kW	HP		0	0.6	1.2	2.4	3.6	4.8	6	7.2	8.4	9.6	10.8	12	13.2	14.4	15.6	
				H	0	10	20	40	60	80	100	120	140	160	180	200	220	240	260	
CB2 - 5CRm 80	CB2 - 5CR 80	2x0.75	2x1	metri	67	66	64	59	53	45.5	37.5	29.5	20.5	12						
CB2 - 4CRm 100	CB2 - 4CR 100	2x0.75	2x1		50	50	49	47	45	42	39.5	37	34	30.5	26.5	22	17	11	5	
CB2 - 5CRm 100	CB2 - 5CR 100	2x0.90	2x1.25		63	62	61.5	59.5	57	53.5	50.5	46.5	42.5	38	33	28	22	15	8	

Q = Portata H = Prevalenza manometrica totale

Tolleranza delle curve di prestazione secondo EN ISO 9906 Grado 3B.

✳ I dati rappresentati nel diagramma e nelle tabelle, indicano le prestazioni con 2 pompe in funzionamento

ASSORBIMENTI

TIPO	TENSIONE
Monofase	230 V
CB2 - 5CRm 80	2 x 5.5 A
CB2 - 4CRm 100	2 x 5.8 A
CB2 - 5CRm 100	2 x 6.8 A

TIPO	TENSIONE
Trifase	400 V
CB2 - 5CR 80	2 x 2.5 A
CB2 - 4CR 100	2 x 2.3 A
CB2 - 5CR 100	2 x 2.5 A

CURVE DI PRESTAZIONE

50 Hz

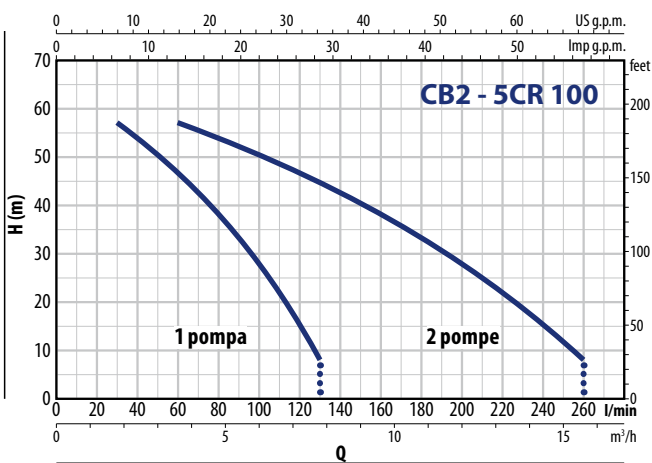
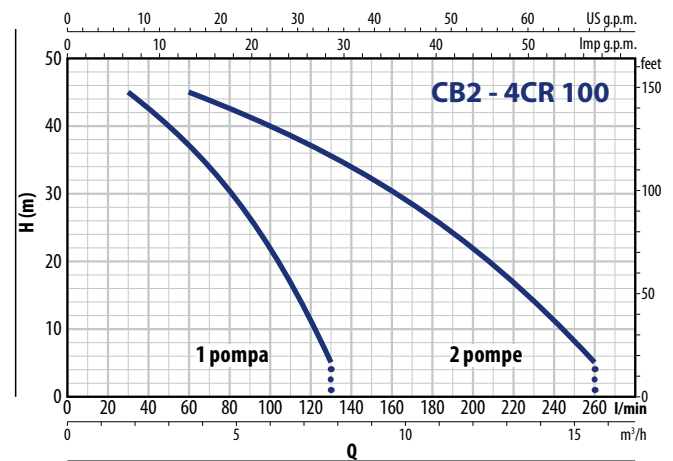
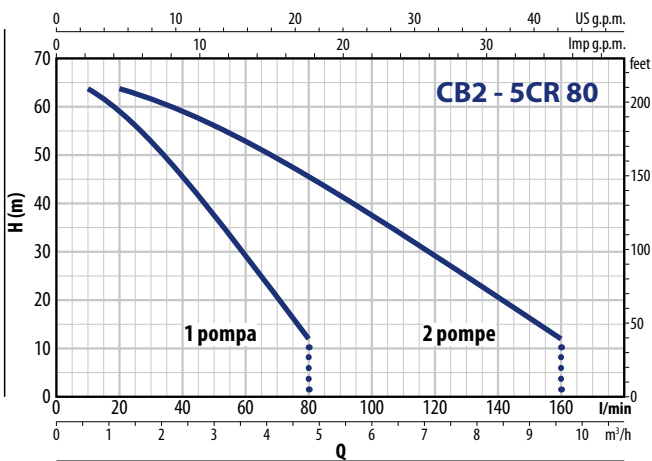

DIMENSIONI E PESI

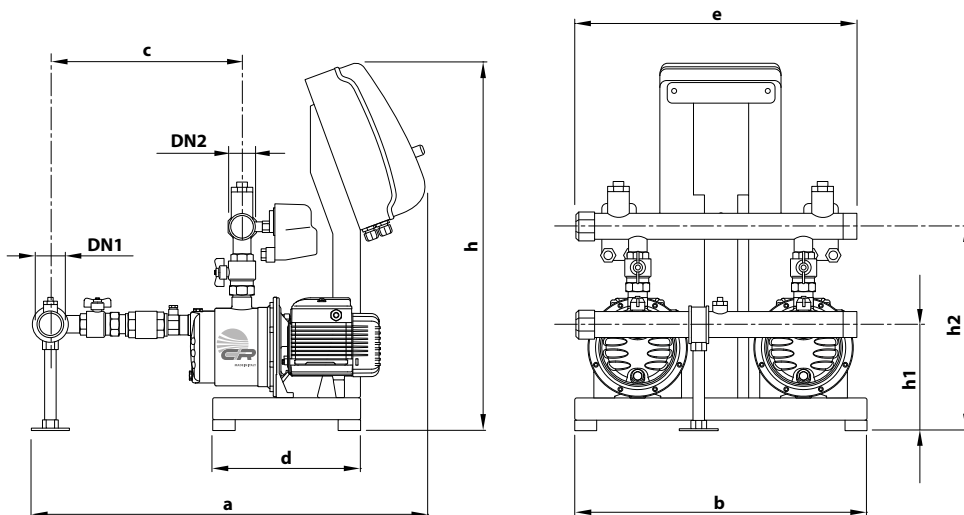

TIPO		BOCCHE		DIMENSIONI mm								kg	
Monofase	Trifase	DN1	DN2	a	b	c	d	e	h	h1	h2	1~	3~
CB2 - 5CRm 80	CB2 - 5CR 80	1½"	1½"	760	530	370	270	510	674	192	373	53	54
CB2 - 4CRm 100	CB2 - 4CR 100	2"	1½"	803	530	408	270	510	674	192	373	54	55
CB2 - 5CRm 100	CB2 - 5CR 100											56	55

CB2 – FCR

CAMPO E DATI DI PRESTAZIONE

50 Hz

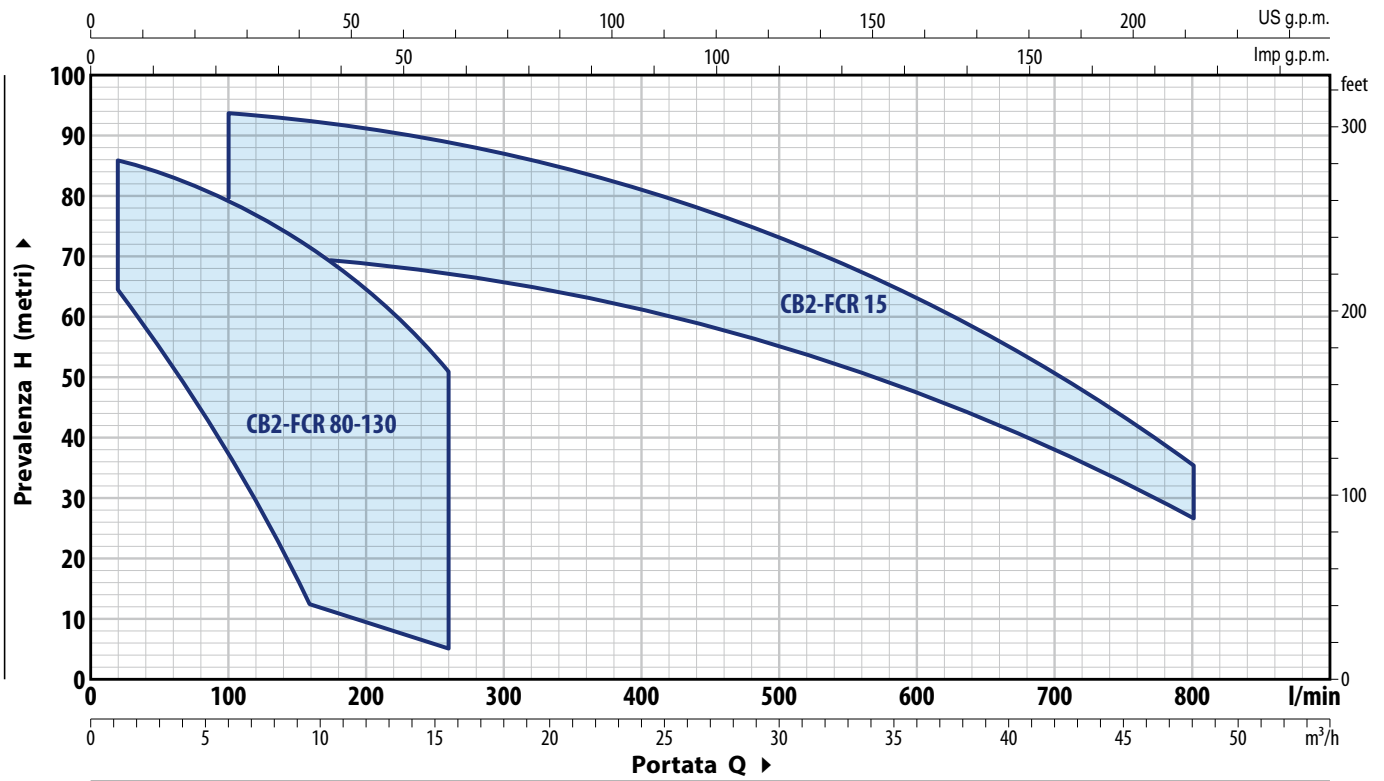

Monofase	TIPO		POTENZA P ₂		Q	H metri														
	Trifase		kW	HP		m³/h	0	0.6	1.2	2.4	4.8	7.2	9.6	10.8	12	13.2	14.4	15.6		
					l/min	0	10	20	40	80	120	160	180	200	220	240	260			
CB2 - FCRm 80/5	-		2x0.75	2x1		67	66	64	59	45.5	29.5	12								
CB2 - FCRm 100/4	-		2x0.75	2x1		50	50	49	47	42	37	30.5	26.5	22	17	11	5			
CB2 - FCRm 100/5	CB2 - FCR 100/5		2x1.1	2x1.5		63	62	61.5	59.5	53.5	46.5	38	33	28	22	15	8			
CB2 - FCRm 90/5	CB2 - FCR 90/5		2x1.1	2x1.5		81	80	79	77	71	62.5	51	44							
CB2 - FCRm 130/4	CB2 - FCR 130/4		2x1.5	2x2		68.5	68.5	68	67	65	62	57.5	55	52	48	45	41			
-	CB2 - FCR 130/5		2x1.8	2x2.5		86	85	85	84	81	77	72	68.5	65	73	67	51.5			

Monofase	TIPO		POTENZA P ₂		Q	H metri						
	Trifase		kW	HP		m³/h	0	6	12	24	36	42
					l/min	0	100	200	400	600	700	800
-	CB2 - FCR 15/3		2x4	2x5.5		72	70	68.5	61	48	38.5	27
-	CB2 - FCR 15/4		2x5.5	2x7.5		96	94	91	81	64	51.5	36

Q = Portata H = Prevalenza manometrica totale

Tolleranza delle curve di prestazione secondo EN ISO 9906 Grado 3B.

✘ I dati rappresentati nel diagramma e nelle tabelle, indicano le prestazioni con 2 pompe in funzionamento

CURVE DI PRESTAZIONE

50 Hz

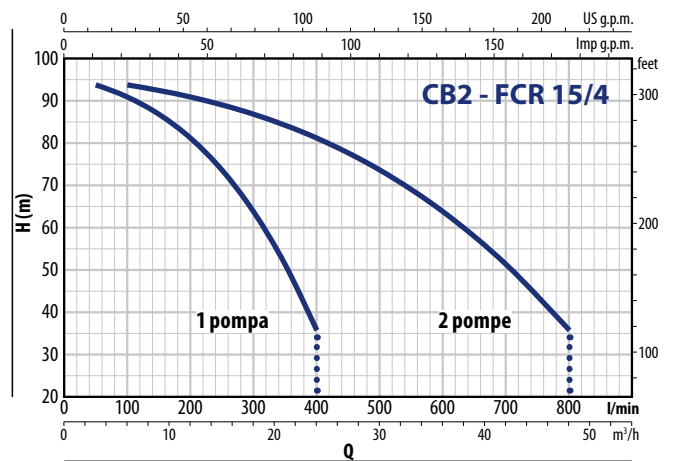
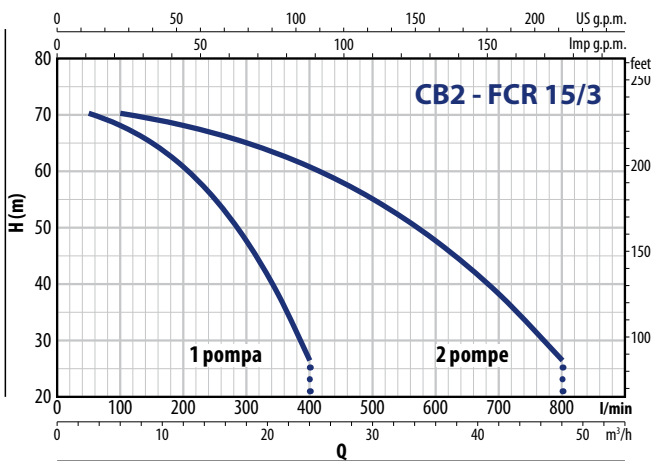
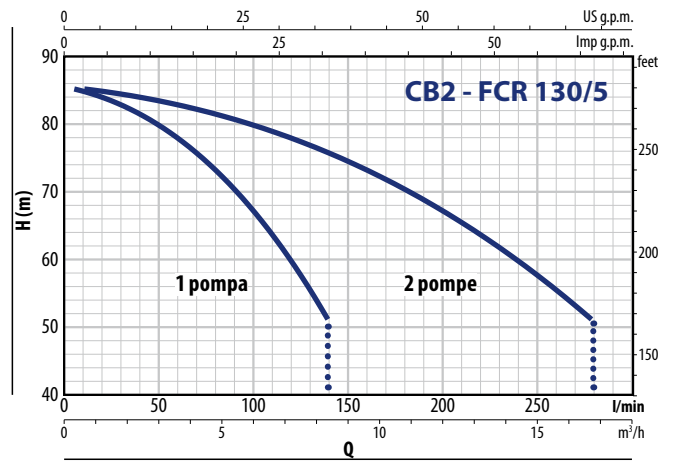
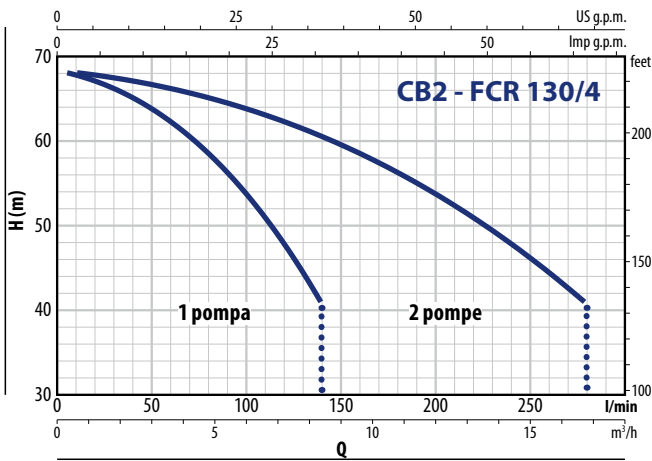
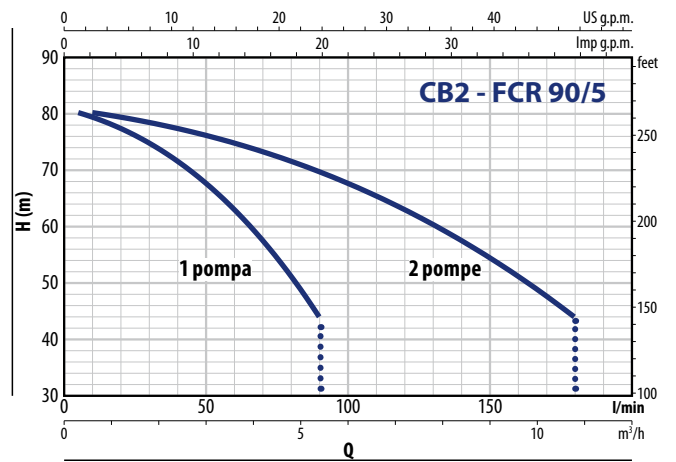
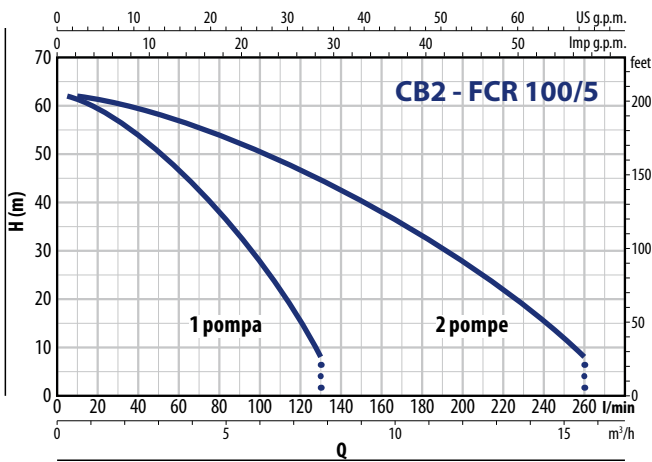
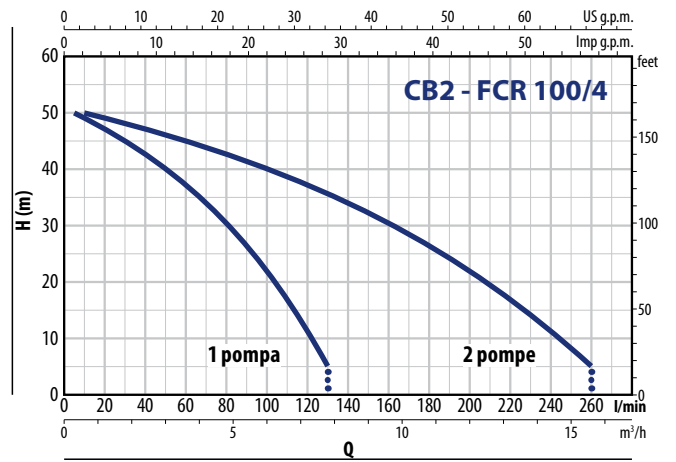
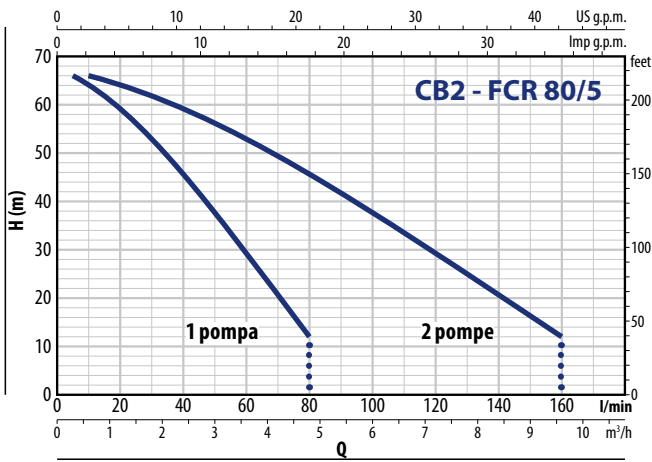

CB2 - FCR

ASSORBIMENTI

TIPO	TENSIONE
Monofase	230 V
CB2 - FCRm 80/5	2 x 5.5 A
CB2 - FCRm 100/4	2 x 5.8 A
CB2 - FCRm 100/5	2 x 6.8 A
CB2 - FCRm 90/5	2 x 9.0 A
CB2 - FCRm 130/4	2 x 10.3 A

TIPO	TENSIONE
Trifase	400 V
CB2 - FCR 100/5	2 x 2.5 A
CB2 - FCR 90/5	2 x 3.5 A
CB2 - FCR 130/4	2 x 4.0 A
CB2 - FCR 130/5	2 x 5.0 A
CB2 - FCR 15/3	2 x 8.8 A
CB2 - FCR 15/4	2 x 11.2 A

DIMENSIONI E PESI

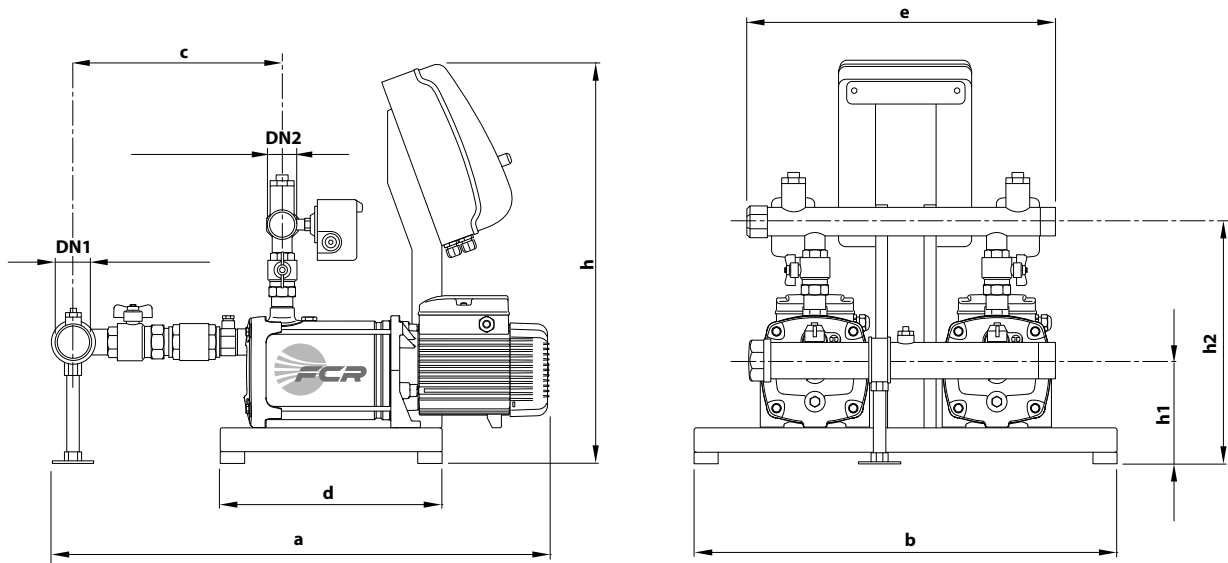

TIPO		BOCCHIE		DIMENSIONI mm								kg	
Monofase	Trifase	DN1	DN2	a	b	c	d	e	h	h1	h2	1~	3~
CB2 - FCRm 80/5	-	1½"	1½"	672		364						53	-
CB2 - FCRm 100/4	-			715	530	401	270			182	368	56	-
CB2 - FCRm 100/5	CB2 - FCR 100/5							510	674				56
CB2 - FCRm 90/5	CB2 - FCR 90/5	2"	1½"	805								82	83
CB2 - FCRm 130/4	CB2 - FCR 130/4			779	700	339	370			205	394	82	83
-	CB2 - FCR 130/5			805									
-	CB2 - FCR 15/3	DN 100	DN 80	1058	700	569	490	774	704	211	565	-	179
-	CB2 - FCR 15/4			4"		3"	1102	613					

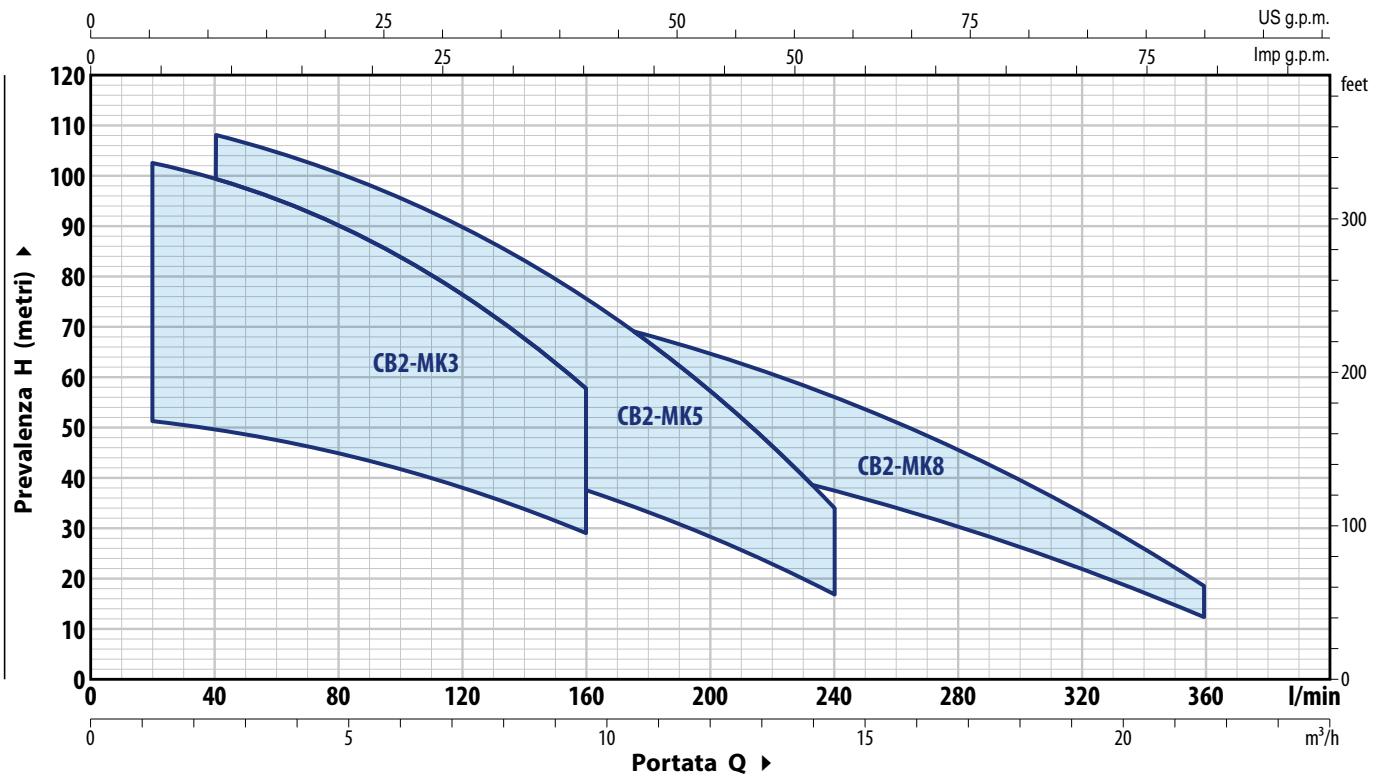

Monofase	TIPO		POTENZA P ₂		Q	H metri												
	Trifase		kW	HP		0	1.2	2.4	4.8	7.2	9.6	12.0	14.4	16.8	19.2	21.6		
					l/min	0	20	40	80	120	160	200	240	280	320	360		
CB2 - MKm 3/3	CB2 - MK 3/3		2x0.75	2x1		52.5	51.5	50	45	38.5	29							
CB2 - MKm 3/5	CB2 - MK 3/5		2x1.1	2x1.5		87	85	83	75	64	48							
CB2 - MKm 3/6	CB2 - MK 3/6		2x1.5	2x2		105	103	100	90	77	58							
CB2 - MKm 5/4	CB2 - MK 5/4		2x0.75	2x1		57	-	54	50	45	37.5	28.5	17					
CB2 - MKm 5/5	CB2 - MK 5/5		2x1.1	2x1.5		71	-	67.5	62.5	56	47	35.5	21.5					
CB2 - MKm 5/7	CB2 - MK 5/7		2x1.5	2x2		99	-	95	88	78	66	50	30					
CB2 - MKm 5/8	CB2 - MK 5/8		2x2.2	2x3		114	-	108	100	90	75	57	34					
CB2 - MKm 8/4	CB2 - MK 8/4		2x1.1	2x1.5		56	-	-	53.5	51	47.5	43	37.5	30.5	22.1	12		
CB2 - MKm 8/5	CB2 - MK 8/5		2x1.5	2x2		70	-	-	67	64	59.5	54	47	38	27.5	15.5		
CB2 - MKm 8/6	CB2 - MK 8/6		2x2.2	2x3		84	-	-	80	77	72	64.5	56	45.5	33	18.5		

Q = Portata H = Prevalenza manometrica totale

Tolleranza delle curve di prestazione secondo EN ISO 9906 Grado 3B.

✳ I dati rappresentati nel diagramma e nelle tabelle, indicano le prestazioni con 2 pompe in funzionamento

CB2 - MK

CURVE DI PRESTAZIONE

50 Hz

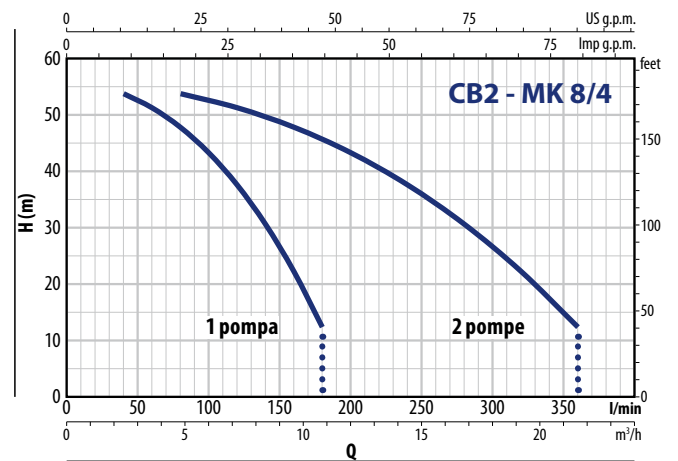
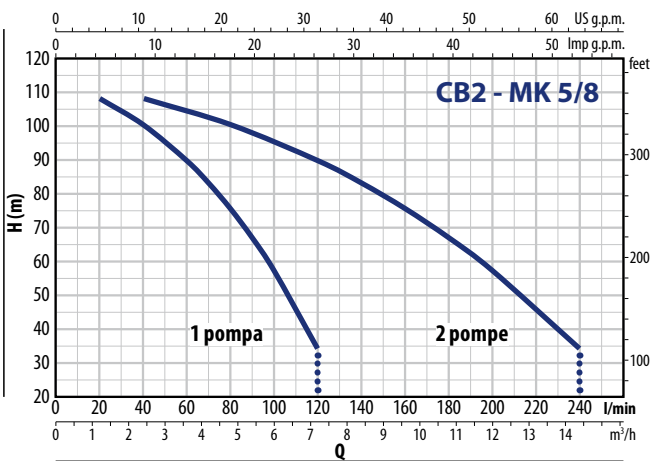
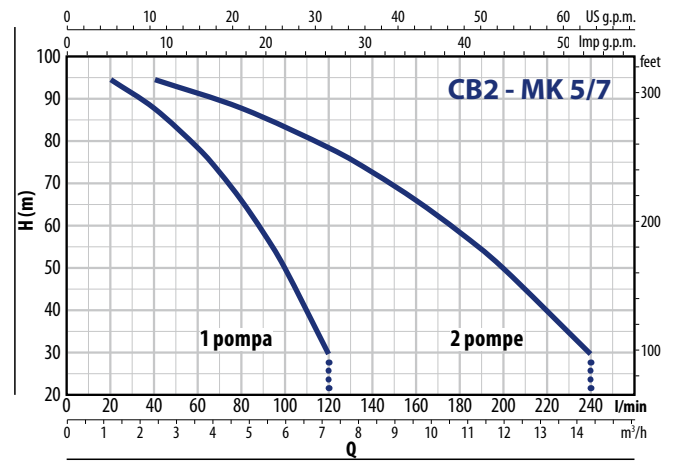
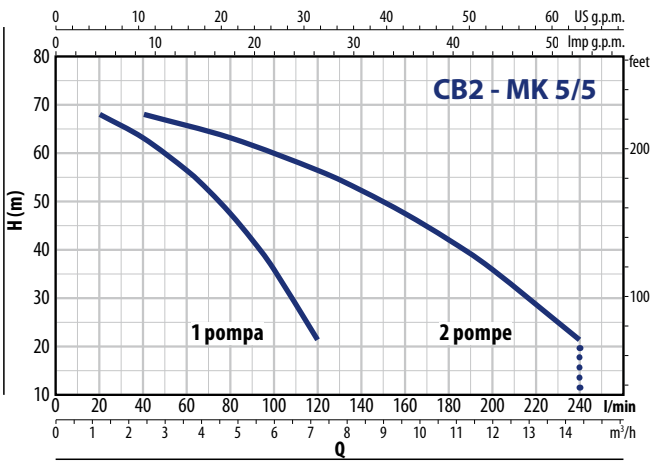
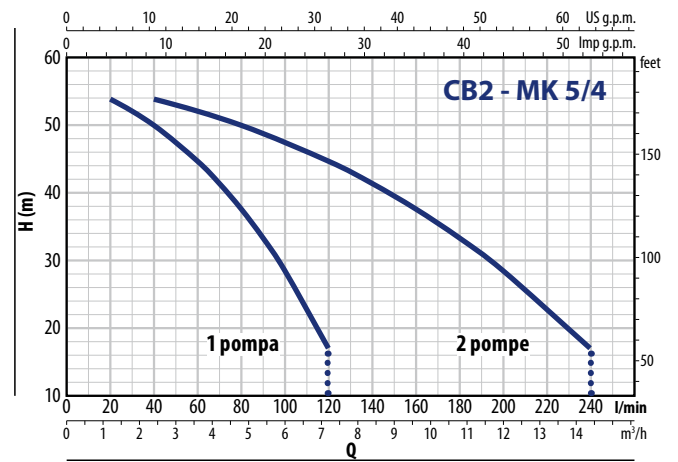
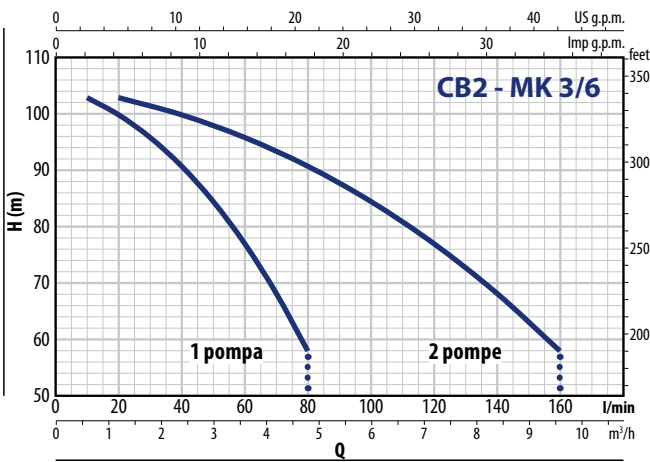
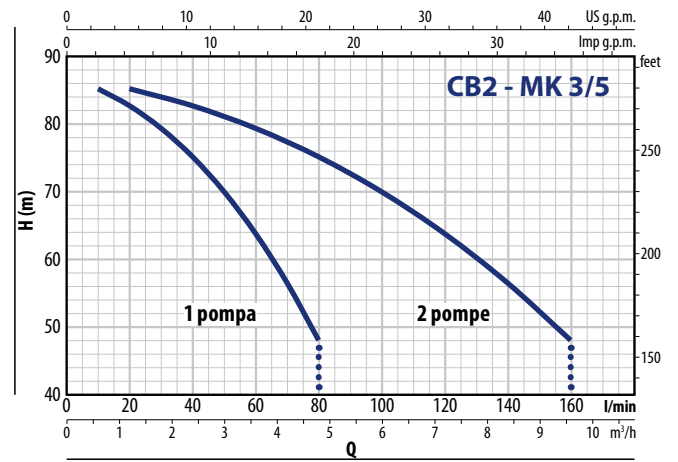
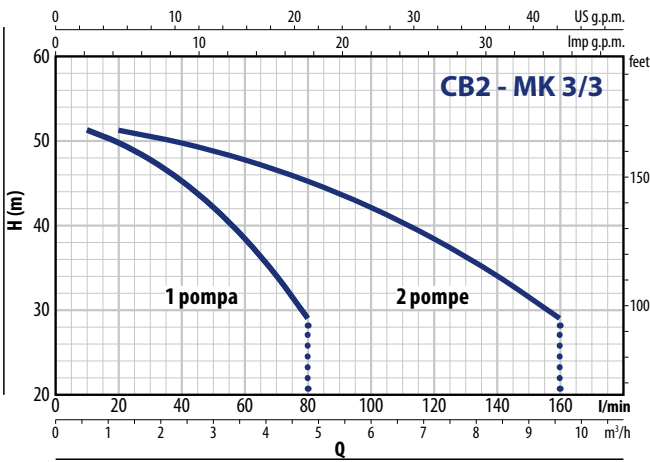

CURVE DI PRESTAZIONE

50 Hz

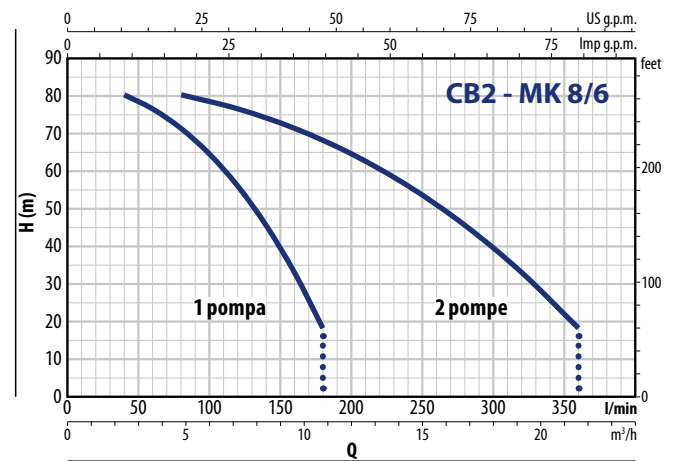
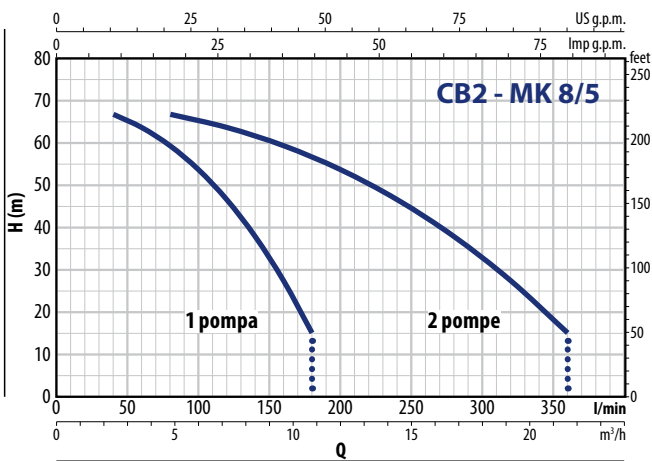

ASSORBIMENTI

TIPO	TENSIONE
Monofase	230 V
CB2 - MKm 3/3	2 x 5.7 A
CB2 - MKm 3/5	2 x 7.8 A
CB2 - MKm 3/6	2 x 9.5 A
CB2 - MKm 5/4	2 x 5.7 A
CB2 - MKm 5/5	2 x 7.1 A
CB2 - MKm 5/7	2 x 9.3 A
CB2 - MKm 5/8	2 x 10.0 A
CB2 - MKm 8/4	2 x 7.8 A
CB2 - MKm 8/5	2 x 9.7 A
CB2 - MKm 8/6	2 x 11.1 A

TIPO	TENSIONE
Trifase	400 V
CB2 - MK 3/3	2 x 2.5 A
CB2 - MK 3/5	2 x 3.0 A
CB2 - MK 3/6	2 x 3.5 A
CB2 - MK 5/4	2 x 2.5 A
CB2 - MK 5/5	2 x 2.7 A
CB2 - MK 5/7	2 x 3.5 A
CB2 - MK 5/8	2 x 4.3 A
CB2 - MK 8/4	2 x 3.0 A
CB2 - MK 8/5	2 x 3.5 A
CB2 - MK 8/6	2 x 4.5 A

CB2 - MK

DIMENSIONI E PESI

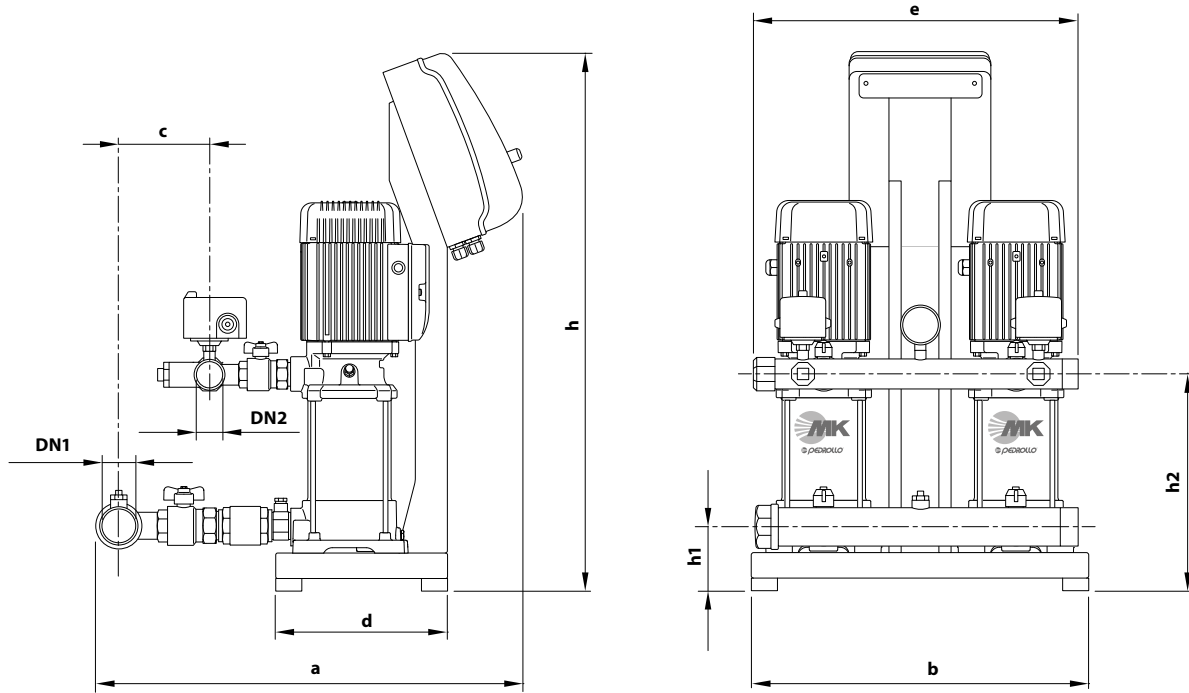

TIPO		BOCCHIE		DIMENSIONI mm								kg	
Monofase	Trifase	DN1	DN2	a	b	c	d	e	h	h1	h2	1~	3~
CB2 - MKm 3/3	CB2 - MK 3/3	2"	1½"	673	530	135	270	510	854	102	234	75.0	73.0
CB2 - MKm 3/5	CB2 - MK 3/5										288	76.0	77.0
CB2 - MKm 3/6	CB2 - MK 3/6										315	80.0	81.0
CB2 - MKm 5/4	CB2 - MK 5/4										261	76.0	74.0
CB2 - MKm 5/5	CB2 - MK 5/5										288	76.0	77.0
CB2 - MKm 5/7	CB2 - MK 5/7										342	81.0	81.0
CB2 - MKm 5/8	CB2 - MK 5/8										369	82.0	82.0
CB2 - MKm 8/4	CB2 - MK 8/4	2½"	1½"	719	530	171	270	510	854	102	261	80.0	81.0
CB2 - MKm 8/5	CB2 - MK 8/5										288	81.0	81.0
CB2 - MKm 8/6	CB2 - MK 8/6										315	87.0	87.0

CAMPO E DATI DI PRESTAZIONE

50 Hz

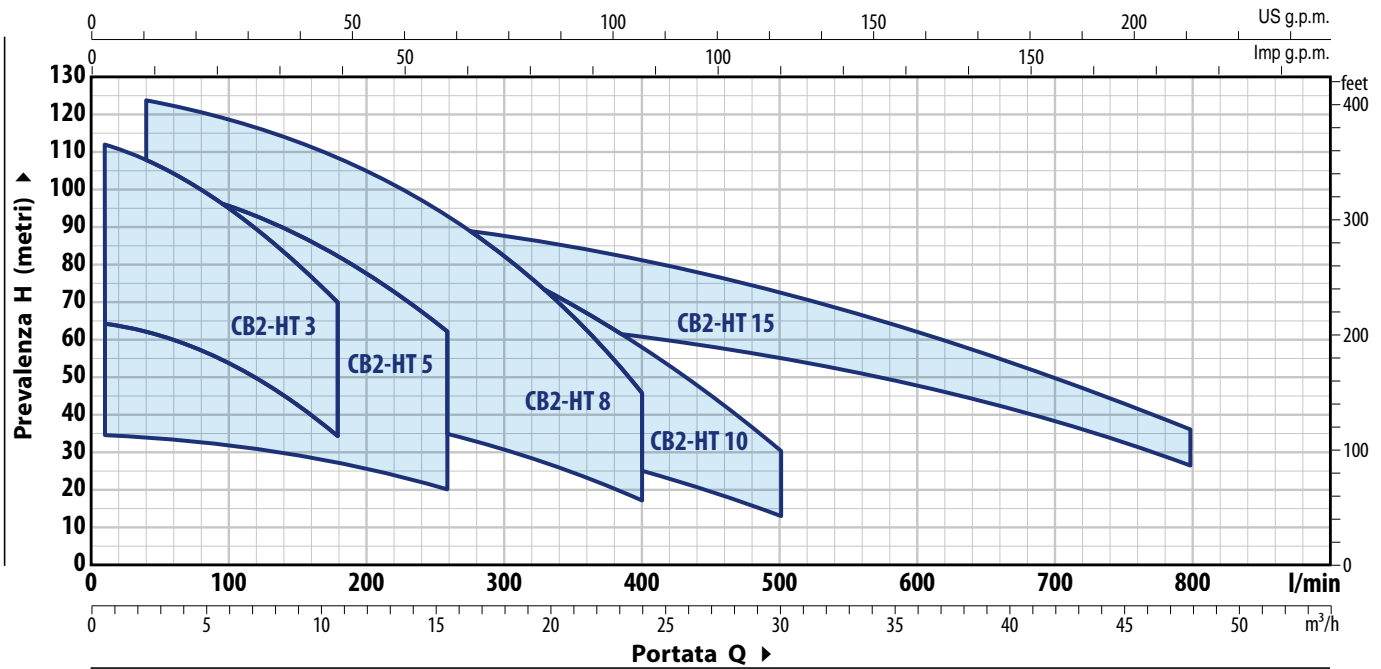

TIPO		POTENZA (P ₂)		Q									
Monofase	Trifase	kW	HP		m³/h	0	0.6	1.2	2.4	4.8	7.2	9.6	10.8
CB2 - HTm 3/4	CB2 - HT 3/4	2x0.75	2x1	l/min	0	10	20	40	80	120	160	180	
CB2 - HTm 3/5	CB2 - HT 3/5	2x1.1	2x1.5	H metri	65	65	63.5	62	57	50	40.5	35	
CB2 - HTm 3/6	CB2 - HT 3/6	2x1.5	2x2		81	80	79	77	71	62.5	51	44	
-	CB2 - HT 3/7	2x1.8	2x2.5		97	96	95	93	86	75	61	52	
					113	112	111	108	100	88	71	61	

TIPO		POTENZA (P ₂)		Q											
Monofase	Trifase	kW	HP		m³/h	0	0.6	1.2	2.4	4.8	7.2	9.6	10.8	12	15.6
CB2 - HTm 5/2	CB2 - HT 5/2	2x0.75	2x1	l/min	0	10	20	40	80	120	160	180	200	260	
CB2 - HTm 5/3	CB2 - HT 5/3	2x1.1	2x1.5	H metri	35	35	32.7	32.3	32.5	31	25.5	27.5	26	20.5	
CB2 - HTm 5/4	CB2 - HT 5/4	2x1.5	2x2		51.5	51.5	51	50.5	49	46.5	43	41	39	31	
-	CB2 - HT 5/5	2x1.8	2x2.5		68.5	68.5	68	67	65	62	57.5	55	52	41	
-	CB2 - HT 5/6	2x2.2	2x3		86	85	85	84	81	77	72	68.5	65	51.5	
					103	103	102	101	98	93	86	82	78	62	

TIPO		POTENZA (P ₂)		Q												
Monofase	Trifase	kW	HP		m³/h	0	2.4	4.8	7.2	9.6	12	14.4	16.8	19.2	21.6	24
CB2 - HTm 8/3	CB2 - HT 8/3	2x1.1	2x1.5	l/min	0	40	80	120	160	200	240	280	320	360	400	
CB2 - HTm 8/4	CB2 - HT 8/4	2x1.5	2x2	H metri	47	46.5	45.5	44	42	39.5	36.5	32.5	28	23.1	17	
-	CB2 - HT 8/5	2x1.8	2x2.5		62.5	62	60.5	58.5	56	53	48.5	43.5	37.5	31	23	
-	CB2 - HT 8/6	2x2.2	2x3		78	77.5	76	73	70	66	61	54.5	47	38.5	28.5	
※	CB2 - HT 8/7	2x3	2x4		94	93	91	88	84	79	73	65.5	56.5	46	34.5	
					109	108	106	103	98	92	85	76	66	54	40	

TIPO		POTENZA (P ₂)		Q												
Monofase	Trifase	kW	HP		m³/h	0	3.6	6	7.2	9.6	14.4	18	20.4	24	26.4	30
※	CB2 - HTm 10/3	2x1.5	2x2	l/min	0	60	100	120	160	240	300	340	400	440	500	
※	CB2 - HTm 10/4	2x1.8	2x2.5	H metri	47	45.5	44	43.5	42	38	33.5	30.5	24.7	20.3	13	
※	-	2x2.2	2x3		62	61	59	58	56	50.5	45	40.5	33	27	18	
※	-	2x3	2x4		77	75.5	74	73	70	63	56	50.5	41	34	21.5	
※	-	2x3	2x4		93	91	88	87	84	76	67.5	61	49.5	40.5	26	
※	CB2 - HT 10/7	2x3	2x4		108	106	103	102	98	88	79	71	57.5	47.5	30	

TIPO		POTENZA (P ₂)		Q							
Monofase	Trifase	kW	HP		m³/h	0	6	12	24	36	42
-	CB2 - HT 15/3	2x4	2x5.5	l/min	0	100	200	400	600	700	800
-	CB2 - HT 15/4	2x5.5	2x7.5	H metri	72	70	68.5	61	48	38.5	27
					96	94	91	81	64	51.5	36

Q = Portata H = Prevalenza manometrica totale

Tolleranza delle curve di prestazione secondo EN ISO 9906 Grado 3B.

※ I dati rappresentati nel diagramma e nelle tabelle, indicano le prestazioni con 2 pompe in funzionamento

CB2 - HT

CURVE DI PRESTAZIONE

50 Hz

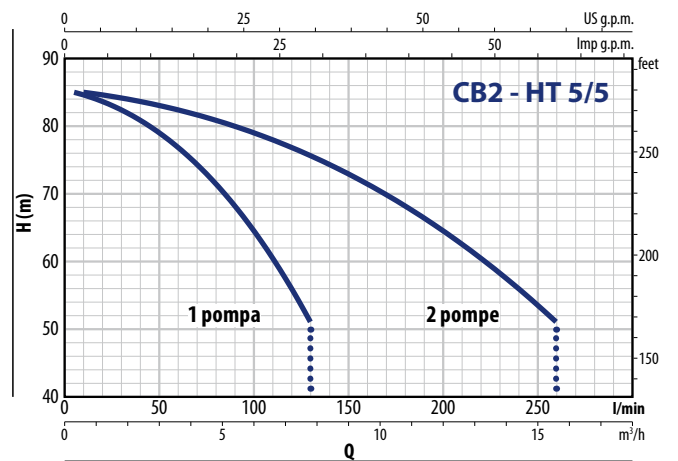
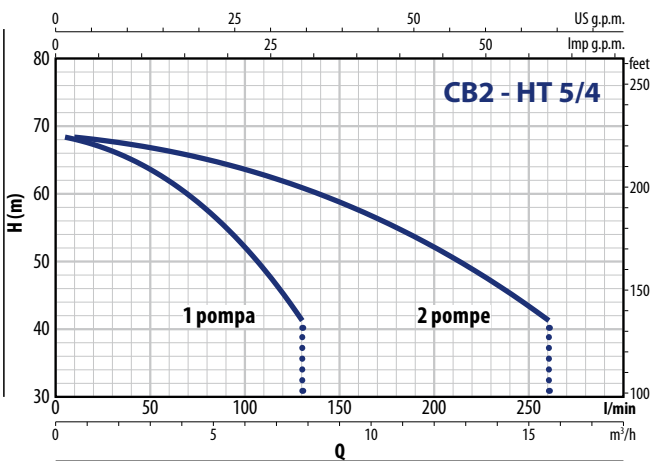
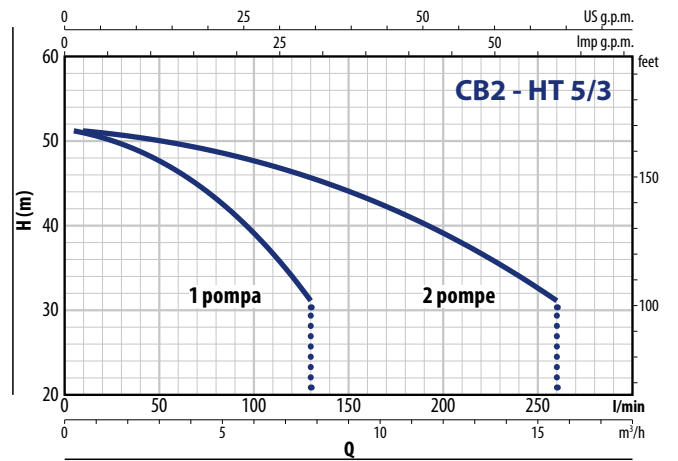
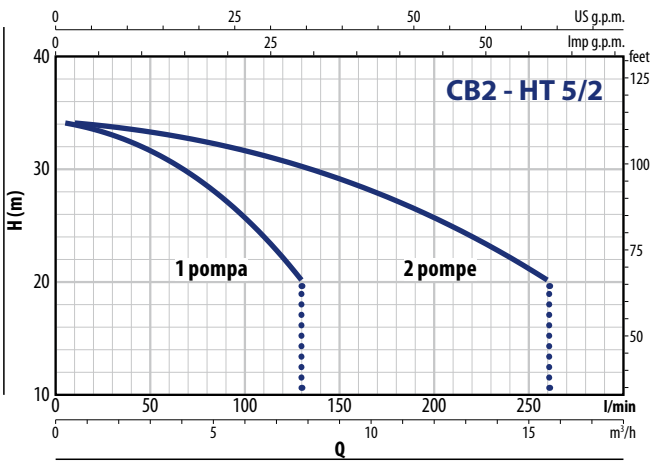
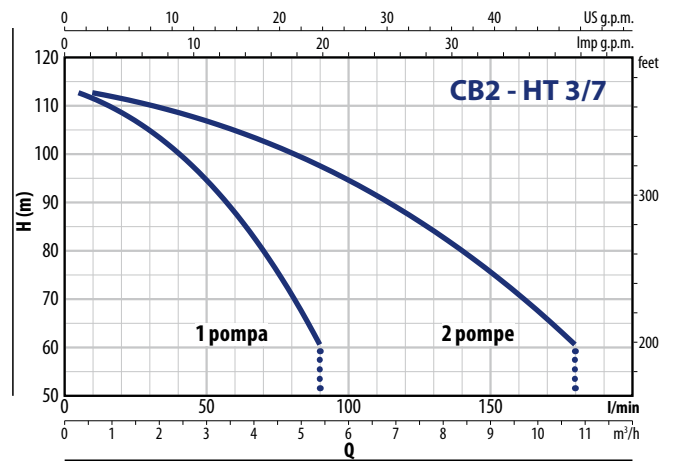
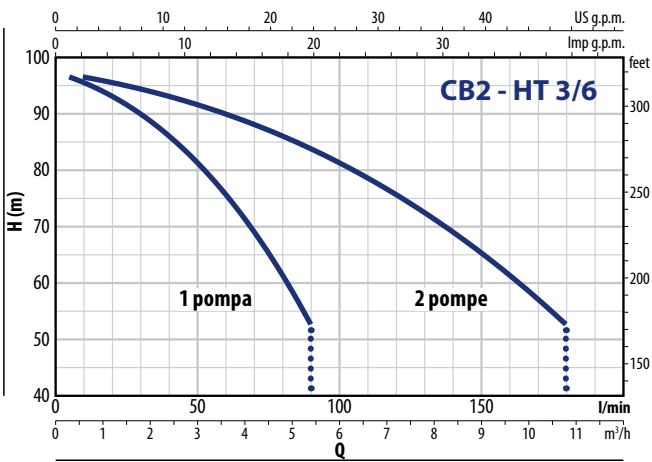
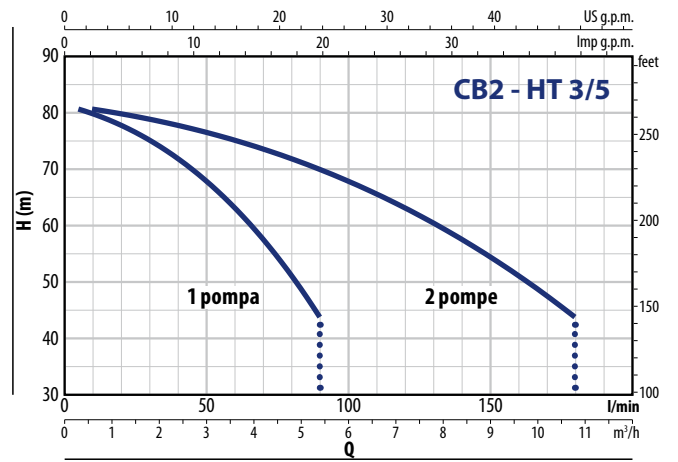
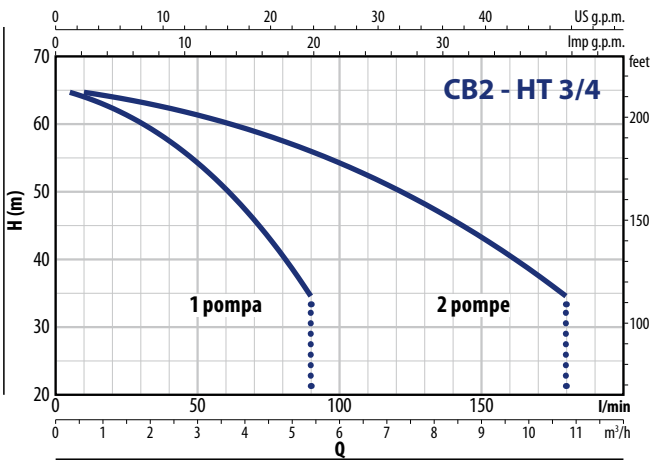

CURVE DI PRESTAZIONE

50 Hz

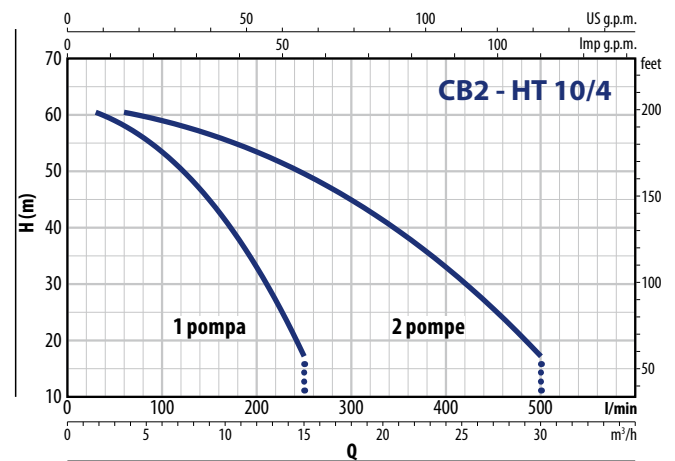
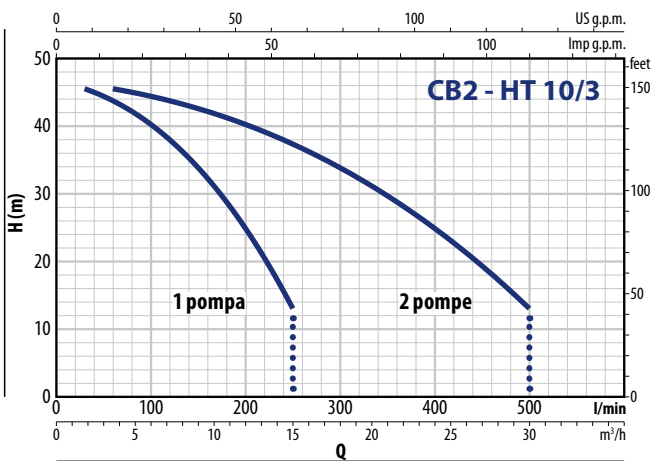
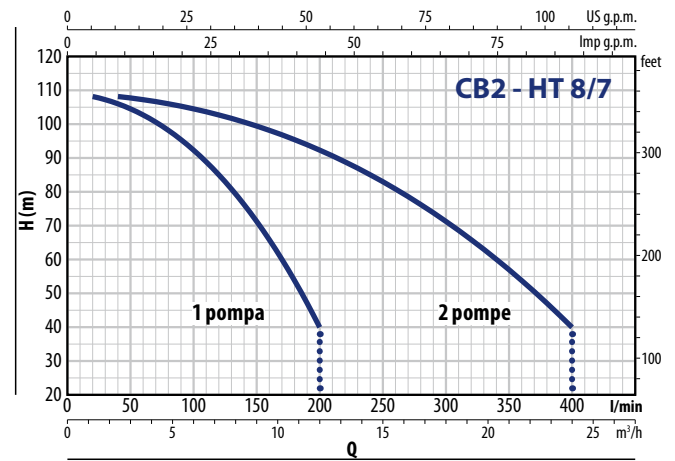
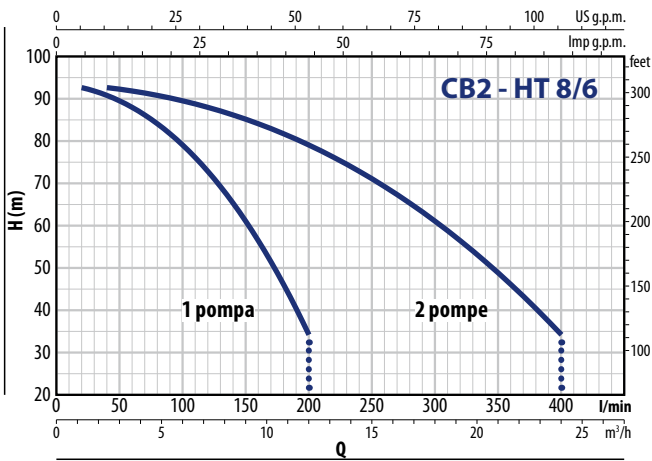
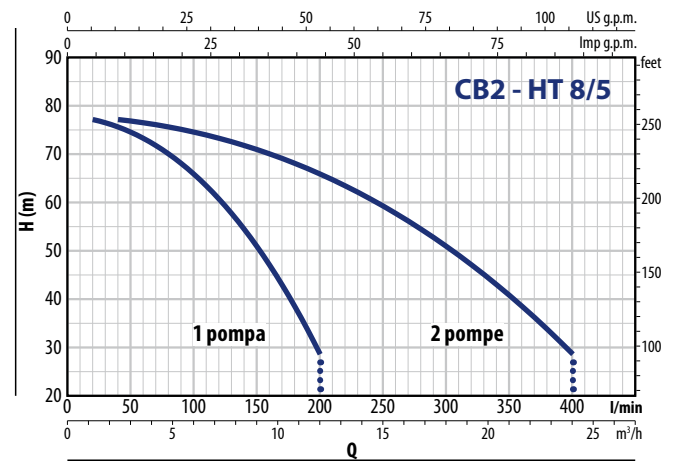
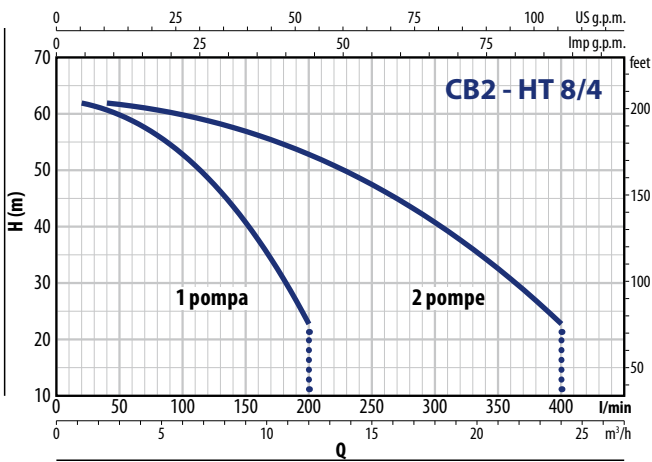
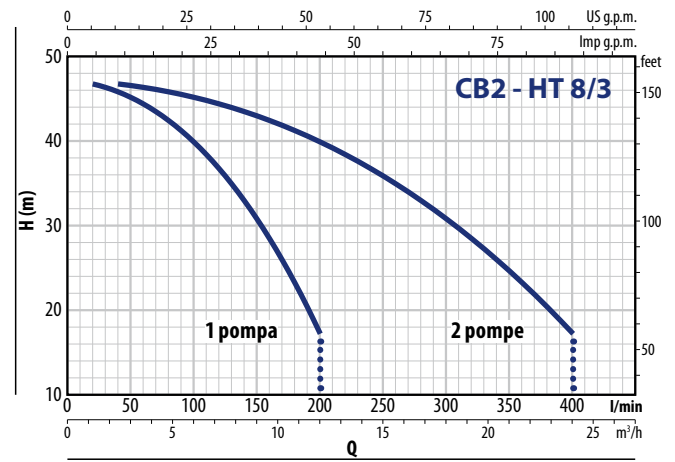
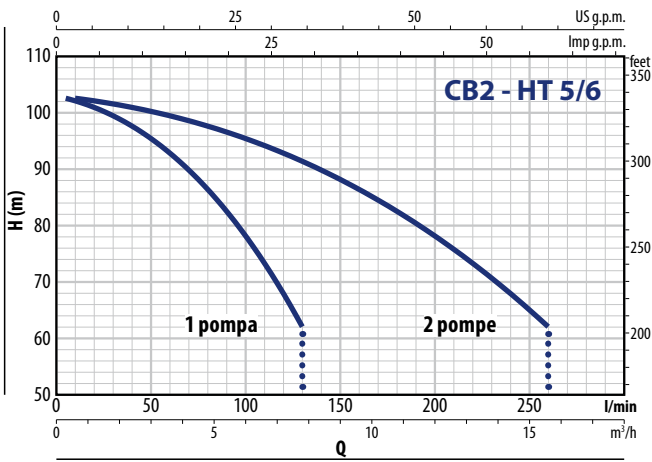

CB2 - HT

CURVE DI PRESTAZIONE

50 Hz

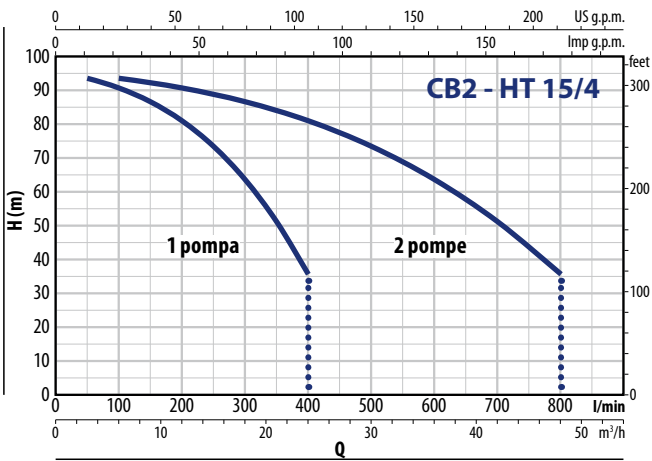
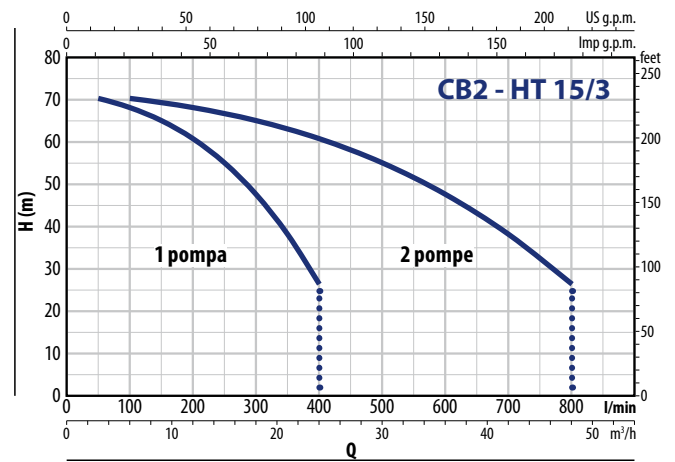
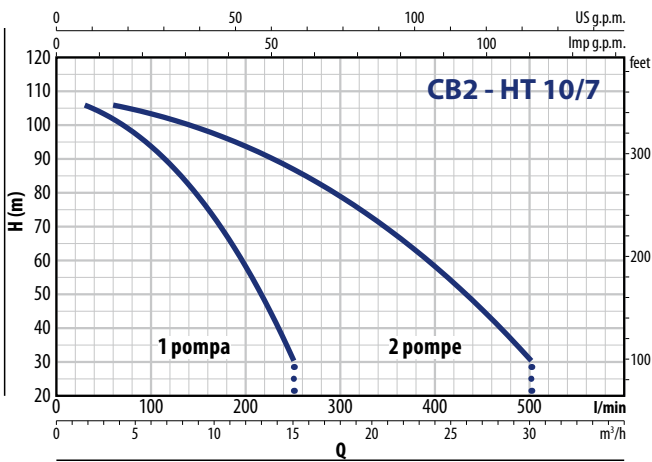
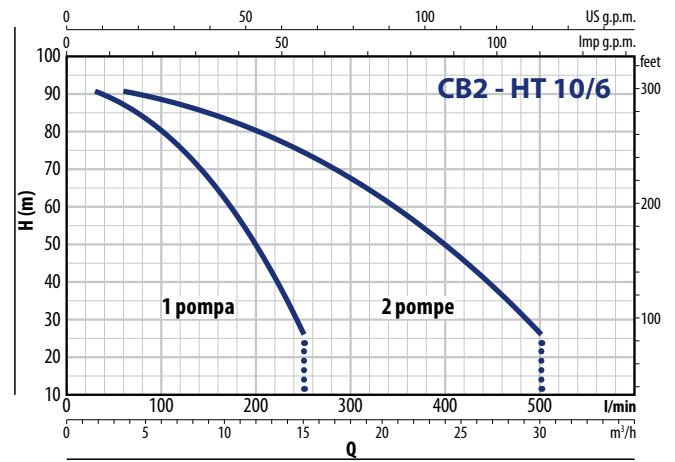
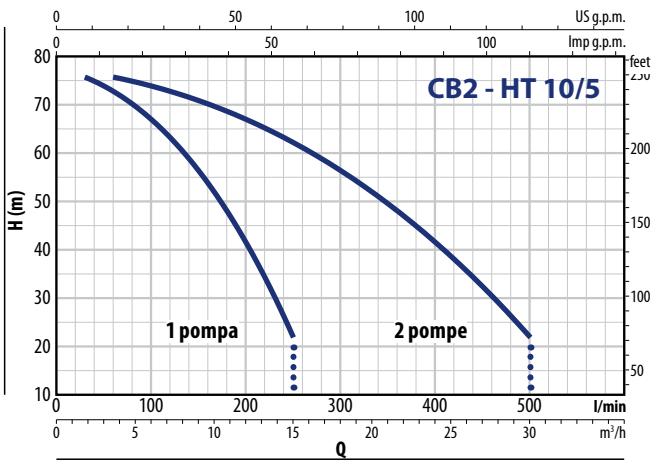

ASSORBIMENTI

TIPO	TENSIONE
Monofase	230 V
CB2 - HTm 3/4	2 x 7.5 A
CB2 - HTm 3/5	2 x 9.0 A
CB2 - HTm 3/6	2 x 10.5 A
CB2 - HTm 5/2	2 x 6.1 A
CB2 - HTm 5/3	2 x 8.5 A
CB2 - HTm 5/4	2 x 10.3 A
CB2 - HTm 8/3	2 x 8.7 A
CB2 - HTm 8/4	2 x 10.5 A
CB2 - HTm 10/3	2 x 9.5 A
CB2 - HTm 10/4	2 x 11.0 A

TIPO	TENSIONE
Trifase	400 V
CB2 - HT 3/4	3.0 A
CB2 - HT 3/5	3.5 A
CB2 - HT 3/6	4.0 A
CB2 - HT 3/7	4.8 A

TIPO	TENSIONE
Trifase	400 V
CB2 - HT 5/2	2 x 2.8 A
CB2 - HT 5/3	2 x 3.2 A
CB2 - HT 5/4	2 x 3.8 A
CB2 - HT 5/5	2 x 4.8 A
CB2 - HT 5/6	2 x 5.2 A
CB2 - HT 8/3	2 x 3.3 A
CB2 - HT 8/4	2 x 4.0 A
CB2 - HT 8/5	2 x 4.8 A
CB2 - HT 8/6	2 x 5.4 A
CB2 - HT 8/7	2 x 7.0 A
CB2 - HT 10/3	2 x 3.4 A
CB2 - HT 10/4	2 x 4.5 A
CB2 - HT 10/5	2 x 5.2 A
CB2 - HT 10/6	2 x 6.5 A
CB2 - HT 10/7	2 x 7.2 A
CB2 - HT 15/3	2 x 8.8 A
CB2 - HT 15/4	2 x 11.2 A

DIMENSIONI E PESI

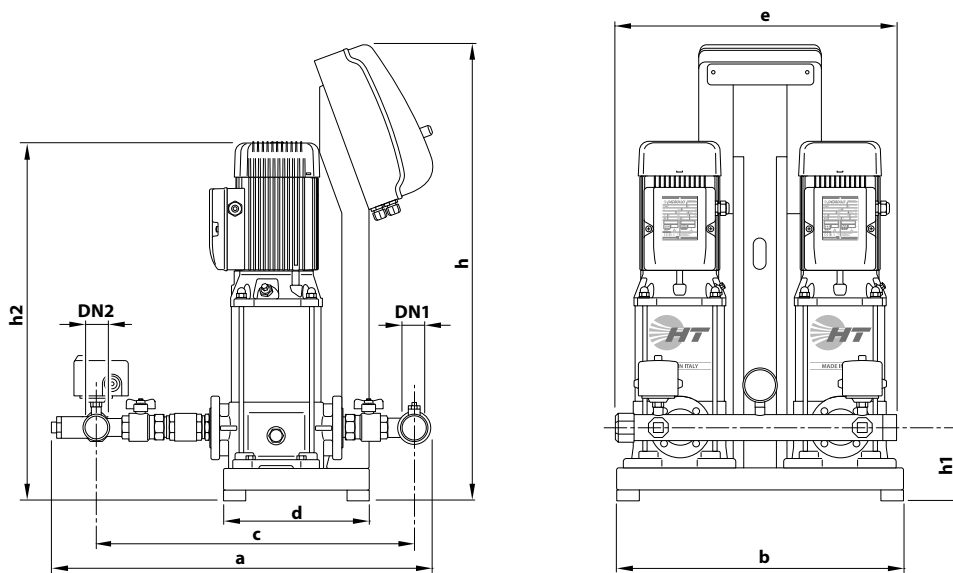

TIPO		BOCCHIE		DIMENSIONI mm							kg		
Monofase	Trifase	DN1	DN2	a	b	c	d	e	h	h1	h2	1~	3~
CB2 - HTm 3/4	CB2 - HT 3/4	2"	2"	732	530	614	270	510	674	135	569	99	100
CB2 - HTm 3/5	CB2 - HT 3/5								595		100	100	
CB2 - HTm 3/6	CB2 - HT 3/6								621		102	102	
-	CB2 - HT 3/7								854		667	-	112
CB2 - HTm 5/2	CB2 - HT 5/2	2"	2"	779	530	661	270	510	674	135	517	99	100
CB2 - HTm 5/3	CB2 - HT 5/3								543		99	100	
CB2 - HTm 5/4	CB2 - HT 5/4								569		103	104	
-	CB2 - HT 5/5								854		615	-	109
-	CB2 - HT 5/6										641	-	111
CB2 - HTm 8/3	CB2 - HT 8/3	2½"	2½"	873	530	738	270	521	674	140	548	106	107
CB2 - HTm 8/4	CB2 - HT 8/4								574		110	111	
-	CB2 - HT 8/5								620		-	119	
-	CB2 - HT 8/6								646		-	120	
-	CB2 - HT 8/7				700		370		674		724	-	145
CB2 - HTm 10/3	CB2 - HT 10/3	2½"	2½"	873	530	738	270	521	674	140	548	107	107
CB2 - HTm 10/4	CB2 - HT 10/4								594		111	111	
-	CB2 - HT 10/5								620		-	119	
-	CB2 - HT 15/3	3"	3"	993	700	850	370	728	674	150	693	-	175
-	CB2 - HT 15/4										737	-	187